

A supplement for use with
STAR TREK[®]
THE ROLE PLAYING GAME

KLINGON

SHIP RECOGNITION MANUAL

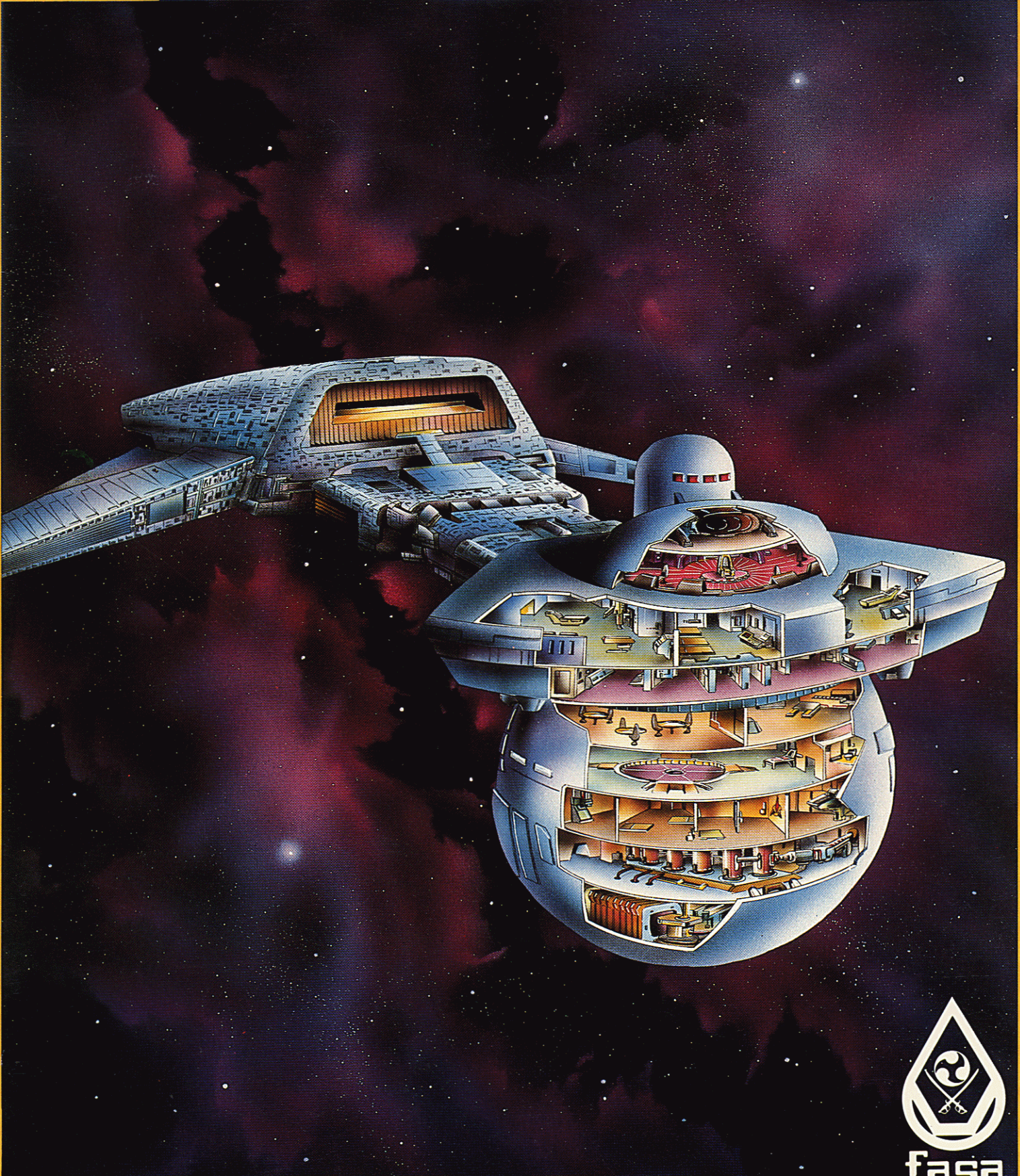

fasa

DANA KNUTSON 85



INTELLIGENCE DATA RELIABILITY RATINGS

Class A

Hard data gathered from physical examination.

Class B

Intelligence projection based on repeated scans/encounters over protracted periods. Class A plans available.

Class C

Intelligence projection based on five or fewer scans/encounters. Class B plans available.

Class D

Intelligence projection based on five or fewer scans/encounters. Class C plans available.

Class E

Speculative projection based on hearsay/transmissions from official/semi-official sources.

Class F

Speculative projection based on hearsay/transmissions from unofficial sources.

CHANGES TO THIS MANUAL

Users of this manual are required to submit changes in the information in this publication pursuant to SFOPS. MAN. 307/A45T. Such changes or other comments regarding this publication must be keyed to the specific page, paragraph, and line of text in which the change is recommended. Reasons should be provided for each comment to insure understanding and complete evaluation.

Comments should be prepared using SFRD Form 2028 (*Recommended Changes to Publication*) and forwarded directly to:

STAR FLEET INTELLIGENCE COMMAND

**Assistant Chief of Staff,
Klingon Sector Intelligence
Williams Port, Titan 01.714**

FOR AUTHORIZED USE ONLY

Unauthorized use, possession, or disclosure of the contents of this manual is strictly prohibited. All violations are treasonous acts against the United Federation of Planets. Failure to comply with directives regarding the use of this manual will result in life imprisonment, death or both.

Classified Documents Directive 998.21C

KLINGON SHIP RECOGNITION MANUAL

INTRODUCTION	3
COMBAT VESSELS	
Assault Ships	
<i>T-3 (Mover)</i>	4
<i>T-5 (Throne Seeker)</i>	4
<i>T-12 (Carrier Of Doom)</i>	5
Battleships	
<i>L-13 (Fat Man)</i>	6
<i>L-24 (Ever-Victorious)</i>	7
Cruisers	
<i>D-7 (Various names)</i>	8
<i>D-4 (Predator)</i>	10
<i>D-9 (Seeker)</i>	11
<i>D-10 (Riskadh)</i>	12
<i>D-20 (Death Rite)</i>	14
<i>D-32 (Stronger Bird)</i>	15
Destroyers	
<i>D-2 (Stingtongue)</i>	16
<i>D-11 (One Wing)</i>	17
<i>D-14 (Stinger)</i>	18
<i>D-16 (Swiftwind)</i>	19
<i>D-18 (Gull)</i>	20
Escorts	
<i>K-23 (Little Killer)</i>	22
<i>K-24 (Winner)</i>	28
<i>K-27 (Grim Reaper)</i>	29
Frigates	
<i>L-6 (Defender)</i>	30
<i>L-9 (Saber)</i>	31
<i>L-42 (Great Bird)</i>	33
Gunboats	
<i>K-3 (Kalath)</i>	34
<i>K-5 (Watcher)</i>	34
<i>K-4 (Enforcer)</i>	35
<i>K-6 (Administrator)</i>	36
Scouts	
<i>K-14 (Pathmaker)</i>	37
<i>K-17 (Deathstalker)</i>	37
<i>K-15 (Unseen Creeper)</i>	38
<i>K-22 (Bird Of Prey)</i>	39
Monitors	
<i>K-30 (Luckless)</i>	40
<i>K-32 (Strong Victor)</i>	41
SUPPORT VESSELS	
Freighters	
<i>G-3 (Baka Re')</i>	42
<i>G-8 (Traders Game)</i>	42
Transports	
<i>G-5 (Tugboat)</i>	43
<i>G-6 (Catapult)</i>	43
Warpshuttles	
<i>W-2 (Koreba)</i>	44
<i>W-4 (Speedster)</i>	44
REPAIR VESSELS AND FACILITIES	
Tenders	
<i>S-4 (Mender)</i>	45
<i>S-5 (Healer)</i>	45
Mobile Repair Facilities	
<i>S-8 (Murph)</i>	46
ORBITAL AND DEEP SPACE STATIONS	
Defense Outposts	
<i>Z-4 (Deathgame)</i>	47
TIME LINES	
Pull-out	23
RECOGNITION SILHOUETTES	
Pull-out	24

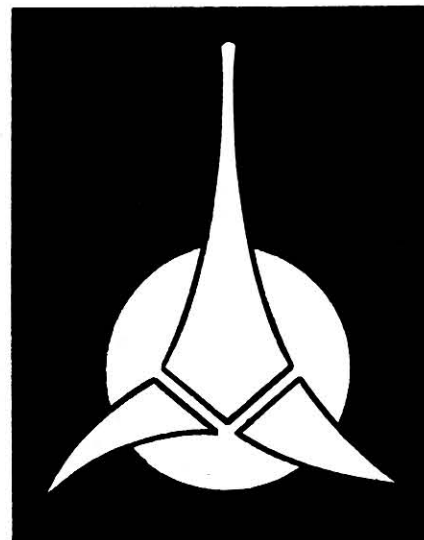

CREDITS

Design

Forest G. Brown

Writing

Forest G. Brown

Editorial Staff

Editing And Additional Writing

Wm. John Wheeler

Proofreading

Donna Ippolito

Illustration And Cover Art

Dana Knutson

Production Staff

Layout And Pasteup

Dana Knutson

Todd F. Marsh

Jane Bigos

David J. Hutchins

Typesetting

Karen Vander Mey

Introduction

THE KLINGON IMPERIAL NAVY

*From the Star Fleet Academy Commencement Address,
Stardate 2/2306.07,
by Admiral L.R. Leeper*

The lengthening shadow cast by the Klingon military machine is not the most ominous threat facing the Federation today. The last twenty years have been witness to extraordinary increases in all aspects of the Klingon armed forces. As the build-up continues unabated, all evidence points to the Klingon intent to achieve dominance in every dimension of military power. The Klingons aspire to advance, step-by step, toward galactic dominance employing every strategem short of purposeless combat.

As a consequence, the principal role of the Klingon Imperial Navy is to support political and economic moves to disrupt the alliance of Federation worlds, sap the vitality of free trade, and insulate the Romulan Star Empire and UFP from each other. Prepared for the eventuality of armed conflict at any level and at any time, the Klingon Imperial Navy has studied the lessons of past wars with great care. Thus it constitutes a many-faceted threat.

SCOPE OF THIS MANUAL

This manual describes the major ships of the Klingon Imperial Navy on a classified basis, providing an overview to authorized Star Fleet Intelligence personnel and line officers concerned with the Klingon Imperial Navy. An effort has been made to provide a comprehensive and objective presentation despite the limitations of space. It is designed for general reading and quick reference.

A historical background of Klingon starships from Stardate 1/8001 to the present is provided. Discussions of all major ships include observations on their weaknesses and strengths, and complete combat data is provided for evaluation. The overall reliability of the data available for each vessel is noted, as well as the primary information source, the records of which may be consulted if a more detailed briefing is necessary.

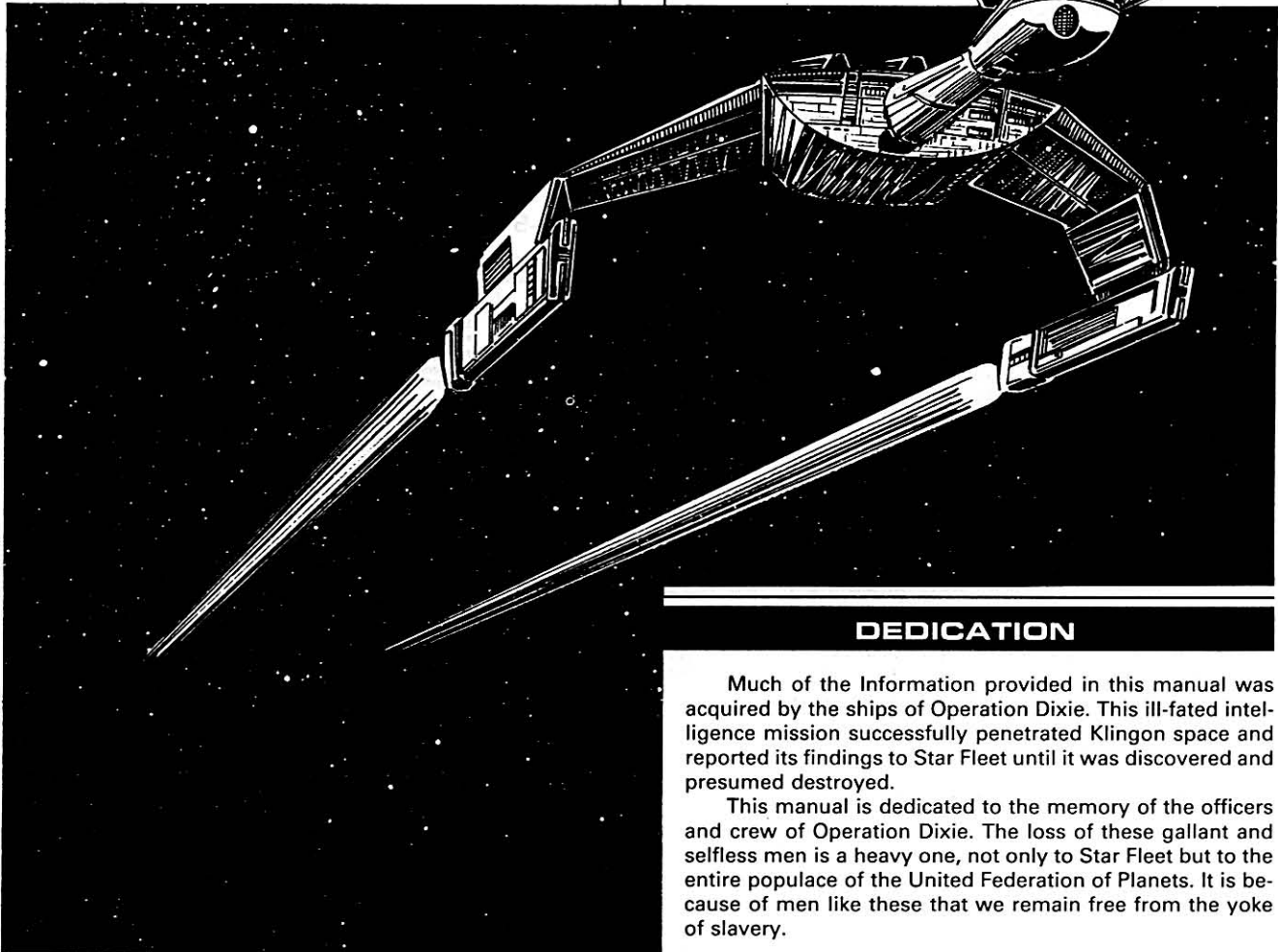

DEDICATION

Much of the Information provided in this manual was acquired by the ships of Operation Dixie. This ill-fated intelligence mission successfully penetrated Klingon space and reported its findings to Star Fleet until it was discovered and presumed destroyed.

This manual is dedicated to the memory of the officers and crew of Operation Dixie. The loss of these gallant and selfless men is a heavy one, not only to Star Fleet but to the entire populace of the United Federation of Planets. It is because of men like these that we remain free from the yoke of slavery.

T-3 (Mover) CLASS VI ASSAULT SHIP

Construction Data:	
Model Numbers —	A
Date Entering Service —	1:9009
Number Constructed —	480
Hull Data:	
Superstructure Points —	10
Damage Chart —	B
Size	
Length —	250 m
Width —	150 m
Height —	50 m
Weight —	73,800 mt
Cargo	
Cargo Units —	1,000 SCU
Cargo Capacity —	50,000 mt
Landing Capability —	None
Equipment Data:	
Control Computer Type —	ZD-5
Transporters	
standard 6-person	6
combat 22-person	6
emergency 18-person	2
cargo	6
Other Data:	
Crew —	62
Troops —	800
Shuttlecraft —	6
Engines And Power Data:	
Total Power Units Available —	30
Movement Point Ratio —	3/1
Warp Engine Type —	KWC-1
Number —	2
Power Units Available —	14
Stress Charts —	LO
Maximum Safe Cruising Speed —	Warp 7
Emergency Speed —	Warp 8
Impulse Engine Type —	KIB-2
Power Units Available —	2
Weapons And Firing Data:	
Beam Weapon Type —	KD-1
Number —	8
Firing Arcs —	6 f p s, 2a
Firing Chart —	B
Maximum Power —	4
Damage Modifiers —	None
Shields Data:	
Deflector Shield Type —	KSC
Shield Point Ratio —	1/1
Maximum Shield Power —	9
Combat Efficiency:	
D:WDF —	41.3/5.6

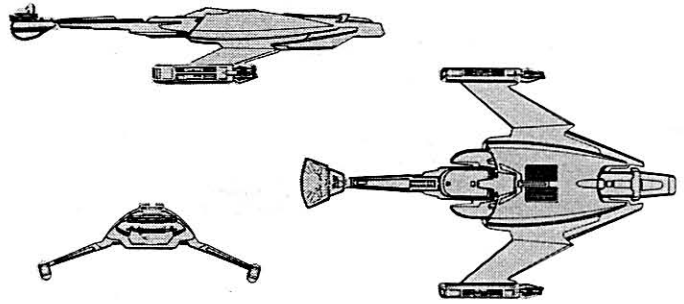

Notes:

Known Sphere Of Operation: Conflict Zones

Data Reliability: B

Major Data Source: Klingon Sector Intelligence

The T-3 is no longer in production. Of the 480 built, 286 remain in active service, 24 are in reserve fleets, 112 have been destroyed, 5 have been scrapped, and 53 have been sold to the civil sector.

The class is named from the Klingon *d'aka*, an obvious reference to its function.

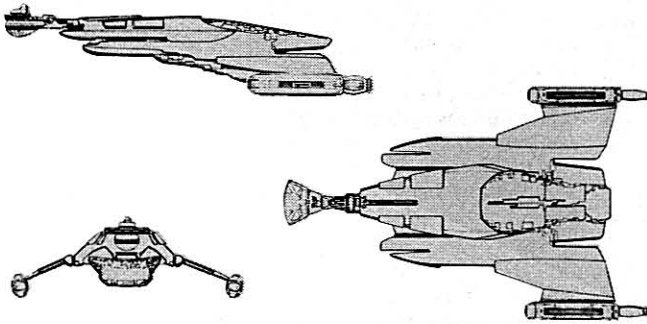

Notes:

Known Sphere Of Operation: Conflict Zones

Data Reliability: B

Major Data Source: Klingon Sector Intelligence

The T-5 is capable of beaming down 292 troops, 8 light support vehicles and 2 tanks every 2 minutes. In less than 10 minutes, 1400 troops, 32 light support vehicles, and 8 tanks can be placed on the ground ready to attack.

Of the 343 built, 21 T-5As and 253 T-5Bs remain in active service. Four T-5s are in reserve fleets, and 47 have been destroyed. Fourteen T-5As and four T-5Bs have been sold to the civil sector. 120 A models have been converted to B models.

T-5s, named from the Klingon *mas to gal*, are being manufactured at Fonawl and Mustaka, where 14 per year of the combined types are produced.



T-5 (Throne Seeker) CLASS VII ASSAULT SHIP

Construction Data:		A	B
Model Numbers —	2:0310-2/2105	2:1211	
Date Entering Service —	210	133	
Number Constructed —			
Hull Data:		10	12
Superstructure Points —		C	C
Damage Chart —			
Size			
Length —	270 m	270 m	
Width —	165 m	165 m	
Height —	60 m	60 m	
Weight —	83,700 mt	88,200 mt	
Cargo			
Cargo Units —	1,200 SCU	1,200 SCU	
Cargo Capacity —	60,000 mt	60,000 mt	
Landing Capability —	None	None	
Equipment Data:		ZD-5	ZD-5
Control Computer Type —			
Transporters			
standard 6-person	6	6	
combat 22-person	10	10	
emergency 18-person	2	2	
cargo, small	8	8	
cargo, large	2	2	
Other Data:		74	76
Crew —	1,400	1,400	
Troops —	15	15	
Shuttlecraft —			
Engines And Power Data:		38	40
Total Power Units Available —		4/1	4/1
Movement Point Ratio —		KWD-1	KWD-1
Warp Engine Type —		2	2
Number —		18	18
Power Units Available —		L/N	L/N
Stress Charts —		Warp 6	Warp 6
Maximum Safe Cruising Speed —		Warp 8	Warp 8
Emergency Speed —		KIB-2	KID-1
Impulse Engine Type —		2	4
Power Units Available —			
Weapons And Firing Data:		KD-1	KD-11
Beam Weapon Type —		6	6
Number —		2f, 1p, 1s, 2a	2f, 1p, 1s, 2a
Firing Arcs —		F	F
Firing Chart —		4	5
Maximum Power —		None	(1 - 4)
Damage Modifiers —		+2	(5 - 8)
		+1	
Shields Data:		KSJ	KSG
Deflector Shield Type —		2.3	1.2
Shield Point Ratio —		13	10
Maximum Shield Power —			
Combat Efficiency:		53.3/4.2	61.2/10.2
D:WDF —			

T-12 (Carrier Of Doom) CLASS IX ASSAULT SHIP

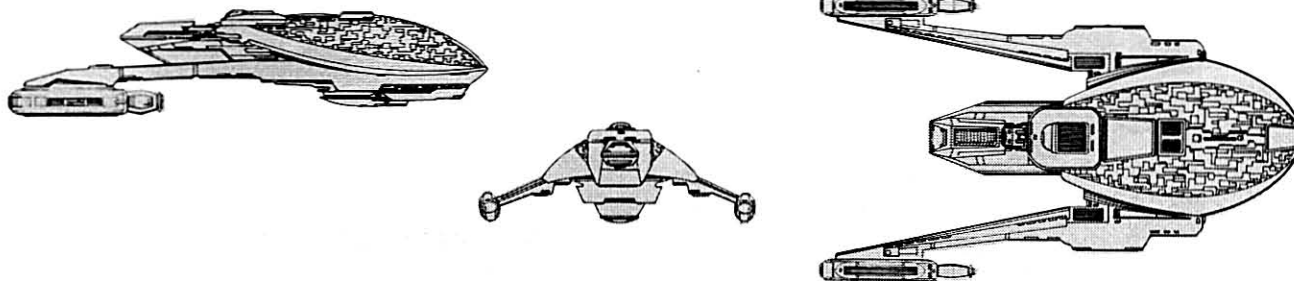

Construction Data:

Model Numbers —	A
Date Entering Service —	2/1405
Number Constructed —	102

Hull Data:

Superstructure Points —	15
Damage Chart —	A
Size	
Length —	300 m
Width —	170 m
Height —	65 m
Weight —	126,200 mt

Cargo

Cargo Units —	3,200 SCU
Cargo Capacity —	160,000 mt
Landing Capability —	None

Equipment Data:

Control Computer Type —	ZD-6
Transporters —	
standard 6-person	8
combat 22-person	10
emergency 18-person	4
cargo	
small	8
large	4

Other Data:

Crew —	82
Troops —	2,400
Shuttlecraft —	14

Engines And Power Data:

Total Power Units Available —	44
Movement Point Ratio —	4:1
Warp Engine Type —	KWE-3
Number —	2
Power Units Available —	20
Stress Charts —	J:M
Maximum Safe Cruising Speed —	Warp 7
Emergency Speed —	Warp 8
Impulse Engine Type —	KID-2
Power Units Available —	4

Weapons And Firing Data:

Beam Weapon Type —	KD-11
Number —	8
Firing Arcs —	2p, 2f, 2s, 2a
Firing Chart —	F
Maximum Power —	5
Damage Modifiers —	
+2	(1 - 4)
+1	(5 - 8)

Shields Data:

Deflector Shield Type —	KSN
Shield Point Ratio —	2:3
Maximum Shield Power —	14

Combat Efficiency:

D WDF —	64.3/13.6
---------	-----------



Notes:

Known Sphere Of Operation: Conflict Zones

Data Reliability: B

Major Data Source: Klingon Sector Intelligence

The T-12 is the largest assault ship in the Klingon navy. With the capability of putting its entire contingent of troops and vehicles on the ground in less than 15 minutes, this vessel is one of the most respected in known space. Its ability to beam down a total of 2400 troops, 56 light support vehicles, and 28 heavy tanks in such a short period of time makes it very difficult for any enemy to repel this force. In most assault operations, these ships are used in groups of three, the number of groups depending on the complexity of the operation.

The largest number of these vessels used in a single operation was on Stardate 2/2003 when the Klingons invaded and captured Mrzicann, a small world outside the Organian Treaty Zone. In this campaign, 24 T-12s beamed their troops and material onto the planet's surface with such speed and precision that the defenders were compelled to surrender in less than twelve hours. Mrzicann's standing army of 800,000 troops was overwhelmed by the element of surprise and, in most cases, gave up without any fight. To prevent a repeat of this occurrence, Star Fleet has stepped up its monitoring of these vessels, keeping track of their location and movements.

The T-12 is capable of traveling at a sustained speed of Warp 7, allowing it to be an integral part of any invading force. Due to the nature of its mission, the T-12 has better engine shielding than most Klingon vessels. This added shielding protects the troops from being over-exposed to the radiation emitted by the warp and impulse systems.

These vessels carry an impressive array of eight disruptors, and so it would seem that these ships could stand in and fight with most any warship. On closer examination, however, the range limitations of the KD-11 make it obvious that the weapons are only for close-in support.

Of the 102 T-12s built, 88 remain in active service, 2 are used by the Imperial Marine Training Command, and 12 have been destroyed. The T-12 is produced at Fonawl, Iosia, and Mustaka, with a combined production rate of 14 per year.

The class is named from the Klingon *na ra'den*, a typical reference to the strike force it can deliver so rapidly.

L-13 (Fat Man) CLASS IX - XI BATTLESHIP

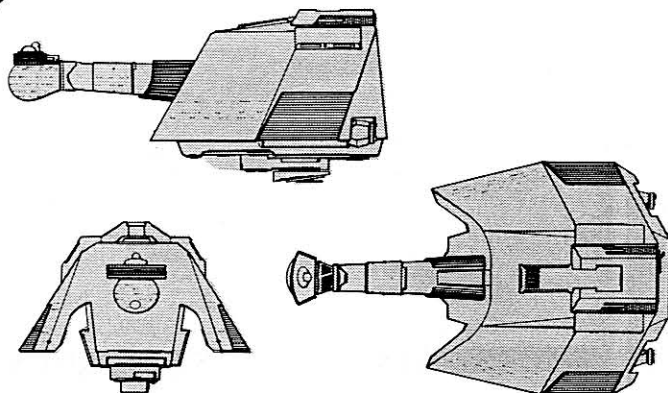

Notes:

Known Sphere Of Operation:

Federation and Romulan Borders

Data Reliability: C

Major Data Source: Klingon Sector Intelligence

The *L-13* was the first attempt by Klingon ship designers to construct a battleship. After the completion of four ships, with four more in various stages of production, it was discovered that the vessels were no better in combat than some of the existing cruisers and frigates.

On Stardate 2/1502, the first successful modification was commissioned, with the *L-13C* models superior in every respect. Their warp capabilities increased by 50%, allowing them to travel at Warp 6. The KWE-2 gave them more efficient power for maneuvering and additional power for the weapons systems. The old KD-7 and KD-10 disruptors were replaced with the more effective KD-9, and the shields were improved and superstructure strengthened.

As the Federation and Romulans continued to upgrade their vessels, the Klingons did likewise. The *L-13D*, introduced on Stardate 2/2009 with the commissioning of two vessels, is equipped with the KWE-3 warp engine and KIF-2 impulse drive, highly efficient engines that give the ships even more power for maneuvering and weapons. Though the disruptor arrangement remains the same as the *C* model, the KP-6 torpedo has been added in both the fore and aft positions. This model also mounts more efficient shields and has an increased superstructure strength. The KCD cloaking device is reported to have been mounted on two of the four ships produced to date.

On Stardate 2/1403, an *L-13A* escorted by six *D-11Ds* attacked a group of Romulan ships near the Triangle. The Romulan force consisted of a Type 1 *V-6 (Gallant Wing)* class cruiser and three Type 7 *T-2 (Death Talon)* class destroyers. The Klingon commander, confident with his new ship, pressed the attack, only to find the Romulan cruiser his equal. After several exchanges of fire, the Klingon force had suffered the loss of 3 *D-11s*, and serious damage, had been done to the *L-13*. The Romulan cruiser had received moderate damage and one destroyer had been eliminated. The Klingons, fearing the loss of the battleship, began to withdraw from the battle. The Romulan commander decided to counterattack the retreating Klingons. The huge battleship still had plenty of fight left and was able to disable another of the Romulan destroyers. At this point, both sides disengaged; the Klingon ships withdrew to Klingon space while the Romulan commander returned to the area of the battle and salvaged what he could of his ships, taking in tow a disabled *D-11*. This skirmish proved to the Klingon Imperial Command that the *L-13* needed improvements. The *B* model was not successful during its tests and was therefore never put into production.

Of the 21 *L-13s* built, 20 remain in active service, and one *A* model is missing and presumed lost. The facilities for constructing the *L-13* are located at Taamar and are estimated to produce up to two per year.

The class, named for the Klingon *k'el ri'anda*, translates to "the dangerous fat man". The brunt of many jokes about being more dangerous to their Klingon crews than the enemy, the *L-13* is known to Star Fleet officers as "the fat man" and as "the turtle".

Construction Data:

Model Numbers —	A	C	D
Ship Class —	IX	X	XI
Date Entering Service —	2/1306	2/1502	2/2009
Number Constructed —	8	9	4

Hull Data:

Superstructure Points —	30	32	34
Damage Chart —	C	C	C
Size —			
Length —	242 m	242 m	244 m
Width —	147 m	147 m	147 m
Height —	110 m	110 m	110 m
Weight —	123,300 mt	158,800 mt	164,300 mt
Cargo —			
Cargo Units —	240 SCU	240 SCU	250 SCU
Cargo Capacity —	12,000 mt	12,000 mt	12,500 mt
Landing Capability —	None	None	None

Equipment Data:

Control Computer Type —	ZD-7	ZD-7	ZD-7
Transporters —			
standard 6-person	4	6	6
combat 22-person	8	8	8
emergency 18-person	2	2	2
cargo	2	3	3
Cloaking Device Type —			KCD
Power Requirement —			48

Other Data:

Crew —	1,048	1,052	1,062
Troops —	392	420	420
Shuttlecraft —	12	14	16

Engines And Power Data:

Total Power Units Available —	41	53	63
Movement Point Ratio —	6/1	5/1	4/1
Warp Engine Type —	KWD-2	KWE-2	KWE-3
Number —	2	2	2
Power Units Available —	12	18	20
Stress Charts —	L/N	J/M	J/M
Maximum Safe Cruising Speed —	Warp 4	Warp 6	Warp 7
Emergency Speed —	Warp 6	Warp 7	Warp 8
Impulse Engine Type —	KIF-1	KIF-1	KIF-2
Power Units Available —	17	17	23

Weapons And Firing Data:

Beam Weapon Type —	KD-8	KD-8	KD-8
Number —	4 in 2 banks of 2	6 in 3 banks of 2	6 in 3 banks of 2
Firing Arcs —	2f p, 2f s	2f p, 2f, 2f s	2f p, 2f, 2f s
Firing Chart —	U	U	U
Maximum Power —	7	7	7
Damage Modifiers —			
+3	(1 - 7)	(1 - 7)	(1 - 7)
+2	(8 - 15)	(8 - 15)	(8 - 15)
+1	(16 - 20)	(16 - 20)	(16 - 20)
Beam Weapon Type —	KD-7	KD-9	KD-9
Number —	3	5	5
Firing Arcs —	2f, 1a	1p/a, 3a, 1s/a	1p/a, 3a, 1s/a
Firing Chart —	L	W	W
Maximum Power —	7	5	5
Damage Modifiers —			
+3		(1 - 7)	(1 - 7)
+2	(1 - 6)	(8 - 15)	(8 - 15)
+1	(7 - 12)	(16 - 20)	(16 - 20)
Beam Weapon Type —	KD-10		
Number —	4		
Firing Arcs —	1p/a, 2a, 1s/a		
Firing Chart —	C		
Maximum Power —	3		
Damage Modifiers —	+1 (1 - 6)		
Missile Weapon Type —			KP-6
Number —			4
Firing Arcs —			2f, 2a
Firing Chart —			R
Power To Arm —			2
Damage —			20

Shields Data:

Deflector Shield Type —	KSH	KSL	KSP
Shield Point Ratio —	1/3	1/3	1/3
Maximum Shield Power —	11	14	15

Combat Efficiency:

D/WDF —	86.3/38.6	110.2/51.6	135.6/85.2
---------	-----------	------------	------------

L-24 (Ever-Victorious) CLASS XIII BATTLESHIP

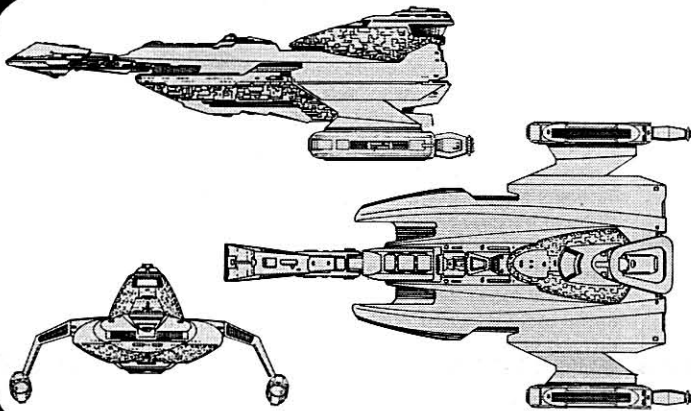

Construction Data:

Model Numbers—	A
Date Entering Service—	2/2204
Number Constructed—	2

Hull Data:

Superstructure Points—	38
Damage Chart—	C
Size	
Length—	320 m
Width—	190 m
Height—	105 m
Weight—	214,000 mt

Cargo

Cargo Units—	300 SCU
Cargo Capacity—	15,000 mt
Landing Capability—	None

Equipment Data:

Control Computer Type—	ZD-8
Transporters—	
standard 6-person	8
combat 22-person	10
emergency 18-person	2
cargo	4

Other Data:

Crew—	1,070
Troops—	480
Shuttlecraft—	20

Engines And Power Data:

Total Power Units Available—	79
Movement Point Ratio—	5:1
Warp Engine Type—	KWG-1
Number—	2
Power Units Available—	28
Stress Charts—	I/M
Maximum Safe Cruising Speed—	Warp 6
Emergency Speed—	Warp 8
Impulse Engine Type—	KIF-2
Power Units Available—	23

Weapons And Firing Data:

Beam Weapon Type—	KD-8
Number—	8 in 4 banks of 2
Firing Arcs—	4f/p, 4f/s
Firing Chart—	U
Maximum Power—	7
Damage Modifiers—	
+3	(1 - 7)
+2	(8 - 15)
+1	(16 - 20)
Beam Weapon Type—	KD-13
Number—	4
Firing Arcs—	2p/a, 2s/a
Firing Chart—	X
Maximum Power—	5
Damage Modifiers—	
+3	(1 - 7)
+2	(8 - 15)
+1	(16 - 22)
Missile Weapon Type—	KP-6
Number—	4
Firing Arcs—	2f, 2a
Firing Chart—	R
Power To Arm—	2
Damage—	20

Shields Data:

Deflector Shield Type—	KSP
Shield Point Ratio—	1.3
Maximum Shield Power—	15

Combat Efficiency:

D/WDF—	153.395.2
--------	-----------



Notes:

Known Sphere Of Operation: Federation Border

Data Reliability: D

Major Data Source:

Klingon Sector Intelligence, Operation Dixie

The L-24 is the largest warship in the Klingon navy. These mammoth ships were commissioned into service prior to the testing of the Federation battleship *Excelsior*. For a short period of time, the balance of power along the borders turned in favor of the Klingons.

The battleship uses the most powerful warp and impulse engines in the Klingon inventory. The combination of these power plants gives these vessels a highly efficient maneuver ratio and allows them to sustain speeds of Warp 6 for long periods of time. The warp engines are mounted on pylons to keep them from the main hull of the ship, and, as with most newer designs, they can be jettisoned in case of emergency. The L-24 differs from other Klingon ships regarding the shielding provided to the engineering technicians. Most other Klingon vessels have minimal engine shielding, and servitor races are trained to operate this equipment; in the L-24, Klingon citizens operate the engines.

The L-24 mounts eight KD-8 disruptors in banks of two, and four KD-13 disruptors. The KD-8s are mounted two banks on the command pod and two banks on the main hull. The KD-13s are mounted on the rear of the main hull. The battleship can fire as many as ten disruptors and two photon torpedoes in some areas of the forward arc, giving this ship a definite advantage in most situations. The KP-6 torpedo, which is mounted in both the fore and aft positions, can inflict as much damage as the most powerful torpedo in the Federation arsenal.

The interior of the battleship is compartmented to reduce the dangers of decompression during battle. This makes the structural integrity of the ship much greater, as seen by the high superstructure strength rating. The deflector shielding for the L-24 is the best the Klingons can produce at this time.

The bridge is located in the forward pod. This typical Klingon bridge design is capable of being separated from the main hull in case of emergency. The bridge of the L-24 has an auxiliary impulse engine that can be used only after separation; it gives the command pod the ability to travel short distances and allows a minimum of maneuvering. The pod mounts two of the KD-8 disruptor banks, which are capable of firing in all directions when separated from the main hull. Also mounted in the pod is a torpedo bay capable of firing torpedoes, though the torpedo storage is minimal.

Like most Klingon warships, this vessel carries assault troops. The 480 troops and their eight light support vehicles are capable of being transported to the ground in less than seven minutes.

As of Stardate 2/2306, only two L-24s have been commissioned into service. Both vessels have been scanned along the Federation border and are known to be working that area. Intelligence gathered from Operation Dixie suggests that new L-24s will be stationed along the Romulan and Triangle borders in the near future.

Further data gained by Operation Dixie shows that these battleships will be produced at two facilities. The first models have been manufactured at the Taamar shipyard, and it is believed that the second facility is being constructed at Gnuu Re'.

The class is named from the Klingon *komo val*, which translates to *always in victory*.

D-7 (Various Names) CLASS VII - IX CRUISER

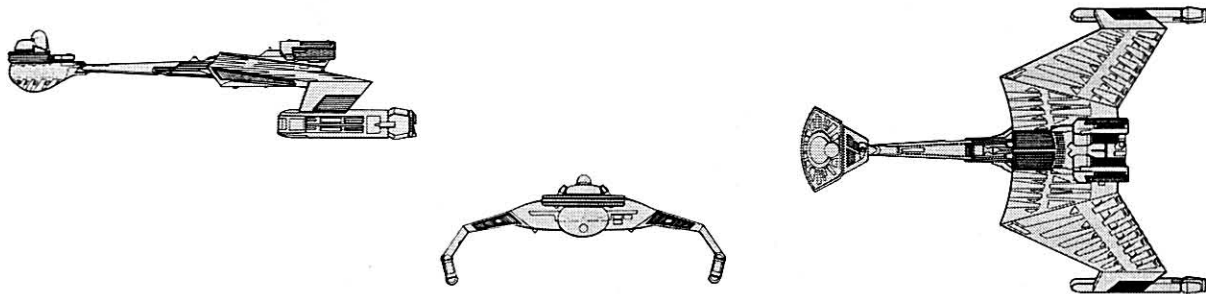

Construction Data:	A	C	G	M	R	S
<i>Model Numbers</i> —	VIII	VII	VIII	IX	IX	IX
<i>Ship Class</i> —	18611	19809-2/2004	2/1012-2/1511	2/1105	2/1203	2/1904
<i>Date Entering Service</i> —	1671	162	16	1244	32	66
<i>Number Constructed</i> —						
Hull Data:						
<i>Superstructure Points</i> —	20	18	20	20	20	22
<i>Damage Chart</i> —	C	C	C	C	C	C
<i>Size</i>						
Length—	216 m	216 m	218 m	221 m	218 m	221 m
Width—	152 m	152 m	152 m	156 m	152 m	156 m
Height—	55 m	55 m	55 m	62 m	55 m	62 m
Weight—	100,300 mt	89,000 mt	100,400 mt	135,000 mt	134,900 mt	139,900 mt
<i>Cargo</i>						
Cargo Units—	120 SCU	120 SCU	100 SCU	120 SCU	80 SCU	160 SCU
Cargo Capacity—	6,000 mt	6,000 mt	5,000 mt	6,000 mt	4,000 mt	8,000 mt
Landing Capability—	None	None	None	None	None	None
Equipment Data:						
<i>Control Computer Type</i> —	ZD-5	ZD-5	ZD-5	ZD-6	ZD-6	ZD-6
<i>Transporters</i> —						
standard 6-person	3	3	3	3	3	3
combat 22-person	5	4	4	5	4	5
emergency 18-person	1	1	1	1	1	1
cargo	2	2	2	2	2	2
<i>Cloaking Device Type</i> —	None	None	None	None	KCC	KCC
<i>Power Requirement</i> —	None	None	None	None	32	32
Other Data:						
<i>Crew</i> —	352	352	360	373	378	375
<i>Troops</i> —	220	180	110	220	110	220
<i>Shuttlecraft</i> —	5	5	5	5	5	5
Engines And Power Data:						
<i>Total Power Units Available</i> —	40	32	40	44	44	44
<i>Movement Point Ratio</i> —	4/1	3/1	4/1	3/1	3/1	3/1
<i>Warp Engine Type</i> —	KWD-1	KWC-1	KWD-1	KWE-3	KWE-3	KWE-3
Number—	2	2	2	2	2	2
Power Units Available—	18	14	18	20	20	20
Stress Charts—	L/N	L/O	L/N	J/M	J/M	J/M
Maximum Safe Cruising Speed—	Warp 6	Warp 7	Warp 6	Warp 8	Warp 8	Warp 8
Emergency Speed—	Warp 8	Warp 8	Warp 8	Warp 9	Warp 9	Warp 9
<i>Impulse Engine Type</i> —	KIC-2	KIC-2	KIC-2	KIC-2	KIC-2	KIC-2
Power Units Available—	4	4	4	4	4	4
Weapons And Firing Data:						
<i>Beam Weapon Type</i> —	KD-6	KD-6	KD-6	KD-8	KD-8	KD-8
Number—	4	7	4	4	6	6
Firing Arcs—	2f p, 2f s	2f p, 1f, 2f s, 2a	2f p, 2f s	2f p, 2f s	2f p, 2f, 2f s	2f p, 2f, 2f s
Firing Chart—	T	T	U	U	U	U
Maximum Power—	6	6	6	7	7	7
Damage Modifiers—						
+3				(1 - 7)	(1 - 7)	(1 - 7)
+2				(8 - 15)	(8 - 15)	(8 - 15)
+1	(1 - 18)	(1 - 18)	(1 - 18)	(16 - 20)	(16 - 20)	(16 - 20)
Missile Weapon Type—			RPL-1	KP-3	RPL-1	KP-4
Number—			1	2	1	2
Firing Arcs—			F	1f, 1a	F	1f, 1a
Firing Chart—			E	R	E	Q
Power To Arm—			10	2	10	2
Damage—			See Chart	15	See Chart	18
Shields Data:						
<i>Deflector Shield Type</i> —	KSC	KSC	KSC	KSK	KSK	KSK
Shield Point Ratio—	1.1	1.1	1.1	1.2	1.2	1.2
Maximum Shield Power—	8	9	8	12	12	12
Combat Efficiency:						
<i>D.WDF</i> —	88.9	118.6	133.5	87.6/33.4	84.6/34.4	87.5/46.4
	54.6/20.4	53.2/35.7	54.6/24.3			

Notes:

Known Sphere Of Operation: Empire-wide use

Data Reliability: A (all models but D-7S); D for D-7S

Major Data Source: All but D-7S in Star Fleet possession; Klingon Sector Intelligence

The D-7 is probably the most infamous cruiser ever to stalk the spacelanes. These ships are associated with death and destruction on a scale second to none. When first introduced, these vessels captured the minds and spirits of the Klingon commanders so fully that for many years they were the symbol of Klingon tyranny.

This design was developed from the earlier D-4 cruiser and incorporated all of its most popular features. The command pod mounted forward on the boom assembly and the wing-like main hull were changed slightly in the design, but all of the basic concepts were retained.

In all models, the command pod can be jettisoned in case of emergency. A small micro-impulse drive system, mounted into the pod just for such emergencies, allows the pod to maneuver itself and travel short distances in hopes of rescue. A pod can maintain the life-support systems and operate the short-range sensors and weapons for up to one year. One of the main features of the pod is the disruptors mounted below the bridge; these weapons will give protection from hostiles and also allow for the self-destruction of the pod if capture is imminent.

The secondary bridge, weapons control, and all engineering facilities are located in the main hull. Separated from the command pod, this section of the vessel is capable of maintaining fully functional life-support, weapons, and engine systems for up to two years. Of course, this section is capable of warp speeds and will effect its own rescue much quicker than can the command pod. Within the engineering

section of the main hull are the matter/anti-matter mix chambers, little shielded, as servitor races man the engineering compartments of most Klingon vessels. All *D-7* models are capable of jettisoning the warp engines in case of an uncontrolled mix in the matter/anti-matter chamber. This would leave the ship with only the impulse engines for power. In most cases where warp engines have had to be ejected, the command pod has been separated first to insure the captain will be safe.

In the center section of the main hull are compartments containing hypothermia capsules for the marines. The troops are kept in a frozen state until they are required, which reduces the requirement for food and life-support and thus prolongs the on-station time of the ship.

Introduced on Stardate 1/8611, the *D-7A* didn't see any action in the Unknown War, but the lessons learned from this conflict were reflected in its design. By Stardate 1/9302, eight separate manufacturing facilities were producing this model at a rate of five per month. When the Four Years War broke out, production of these ships soared to twelve per month within the first year and peaked at 26 per month by the third year. The Klingons, having brought the war on, were ready with over 400 of these ships in the front-line; studies have shown that this numerical advantage was the prime factor in their early advances into Federation territory. On a one-to-one basis, Federation cruisers and frigates were far superior as warships, but their limited numbers prevented them from turning the Klingons back in the early stages of the war. The *D-7A* class, named "Painbringer" from the Klingon *K't'agga*, served the Klingon Imperial Navy well in the war with a high reliability rating and ease of repairs.

Of the 1671 *D-7As* produced, 431 remain in active service, 83 have been placed in reserve fleets, 12 are used by the Klingon Naval Academy as training vessels, 891 have been destroyed, 23 have been captured (10 by Star Fleet and 13 by the Romulans), 15 are listed as missing, 26 have been scrapped, 170 have been traded to the Romulans, and 20 have been sold to ranking families within the empire.

The *D-7C*, introduced at the close of the Four Years War, saw no action in that conflict, but it was given its baptism of fire just seven months after entering service. The *D-7Cs* involved in the incident were so badly outclassed by their Romulan adversaries that the design was never fully accepted by starship captains, and the model was finally removed from service on Stardate 2/2004.

The *D-7C*, named "Bringer Of Destiny" from the Klingon *k't'kara*, had more efficient warp engines than those mounted on the *D-7A*, but they were incapable of powering all the weapons even though the ship was more maneuverable. The designers felt that the increased warp speed and maneuvering ratio would make this ship more cost-effective, even though it was a dismal failure because of it failed to meet its design requirements as a gunship due to its inability to power all its disruptors during combat. Furthermore, though the *D-7C* had slightly improved shielding, this advantage was lost due to its weaker superstructure. For some unexplained reason, Klingons have never put larger warp engines on this ship, though it seems that, if this had been done early in its career, it certainly would have outclassed anything the Romulans or Star Fleet had at the time.

Of the 162 *D-7Cs* built, 52 have been placed in reserve fleets, 65 have been destroyed, 13 captured (9 by Star Fleet and 4 by the Romulans), 4 listed as missing, 18 sold to the Orions, 6 sold to prominent families within the Empire, and 4 sold to private groups or individuals in the Triangle.

The *D-7G*, named "Truthbringer" after the Klingon *k't'alla*, was the direct result of the first Romulan-Klingon technology exchanges, as part of which the Klingons received 24 Romulan plasma weapons of the RPL-1 type. Sixteen of these were immediately installed on *D-7s*, and the remaining weapons were given to weapons research firms within the Empire. The conversions to *D-7Gs* were made on *D-7As*, which otherwise remained the same. The plasma weapon design required the ship to be close to the enemy in order to fire, and most Klingon commanders did not like the tactics that the weapon dictated, hence no Klingon commander felt comfortable with the conversions.

Of the 16 *D-7Gs* built, 10 were converted to *D-7Rs*, 4 were destroyed, 1 was captured by Star Fleet, and 1 is in the service

of a ranking family within the Empire.

The *D-7M*, introduced on Stardate 2/1105, was a match for the Federation *Constitution* and Romulan *V-6 (Gallant Wing)* cruisers. This gave the Klingon navy a slight advantage along its borders, and the Imperial Command began to press the balance more aggressively. Both the Romulan navy and Star Fleet commissioned upgraded versions of their vessels shortly after the appearance of the *D-7M* in order to hold the Klingons in check. Within two years after its introduction into service, 75% of all facilities producing the *D-7A* had been converted to manufacture the *D-7M*, allowing the Klingons to place more and more of these ships in sensitive areas. As the Klingons grew bolder, these ships began to appear in the Organian Treaty Zone and in the Triangle. Traveling in groups of threes, sorties were made by Klingon commanders into areas that were declared neutral or de-militarized, and several worlds were subjugated by small forces of these ships.

The *D-7M* mounts the KWE-3 warp engine, which (in this configuration) gives more efficient power for maneuver and added power for the weapons systems; this warp drive system allowed the *D-7* to travel at Warp 8 and, in an emergency, Warp 9. The KD-6 disruptors were replaced with the more powerful KD-8s, extending the offensive range of the ship to 200,000 km. An additional improvement, giving a punch that surprised many Romulan and Star Fleet commanders when first encountered, was the KP-3 photon torpedo mounted both fore and aft. Improved shielding was also added, increasing its capabilities by 50%.

Several vessels of this type, named "Bringer Of Destruction" from the Klingon *k't'inga*, have gained a level of fame equal to that of the *USS Enterprise*, most notably the *IKV Bardur*. The *Bardur* is known to have destroyed over 20 Romulan vessels, 10 Federation vessels, and participated in skirmishes that have accounted for the loss of over 40 enemy ships. The captain of this ship has been promoted to Admiral and, much like his Federation counterpart, remains in command of his vessel, now the smallest ship in known space to be a fleet flagship. The current position of this fleet is in the Orion sector, operating from the border starbase located there.

Of the 1244 *D-7Ms* built, 965 remain in active service, 198 have been destroyed, 8 have been captured (5 by Star Fleet and 3 by the Romulans), 11 have been scrapped, 36 are in the service of ranking families of the Empire, and 21 have been reported as missing. Three of those missing were destroyed during the V'ger incident, and several others are known to be operating in the Triangle under the command of renegade Klingons.

The *D-7R*, named "Bringer Of Agony" after the Klingon *k't'rika*, was another attempt by the Klingons to make use of the plasma weapons, this time incorporated into the improved *D-7M* hull with the photon torpedo bays removed. The RPL-1 was placed in the bow of the ship and an additional KD-8 disruptor was placed in the aft compartment. In addition to these changes, a KCC cloaking device was added. The Klingons had learned by this time that the plasma weapon and cloak were designed to be used together, often by remaining cloaked and stationary in the path of their adversary before decloaking and firing the plasma bolt at minimum range.

Of the 32 *D-7Rs* built, 29 remain in active service, 2 have been destroyed, and 1 has been captured by Star Fleet.

The *D-7S*, the newest of this line of cruisers, is an improved version of the *D-7M*, appearing to be a *D-7M* at first glance. Only well-trained personnel will be able to tell the difference on a sensor scan, but these cruisers mount six KD-8 disruptors and fore- and aft-firing KP-4 torpedoes. In addition, some models carry the KCC cloaking device.

The *D-7S*, named "Bringer Of Justice" from the Klingon *k't'mara*, is being produced at the same facilities as the *D-7M*, which intelligence reports show will be phased out for this much-improved version; the facilities at Taamar, Gnuu Re', losia, H'rez, and Z'hai are producing 40 *M* models and 22S models per year. Of the 66 *D-7Ss* built, 65 remain in active service and one has been listed as missing. Although Star Fleet has encountered these vessels, none have been destroyed or captured. Orion reports from within the Triangle suggest that the Klingons are operating several small groups there.

D-4 (Predator) CLASS VII CRUISER

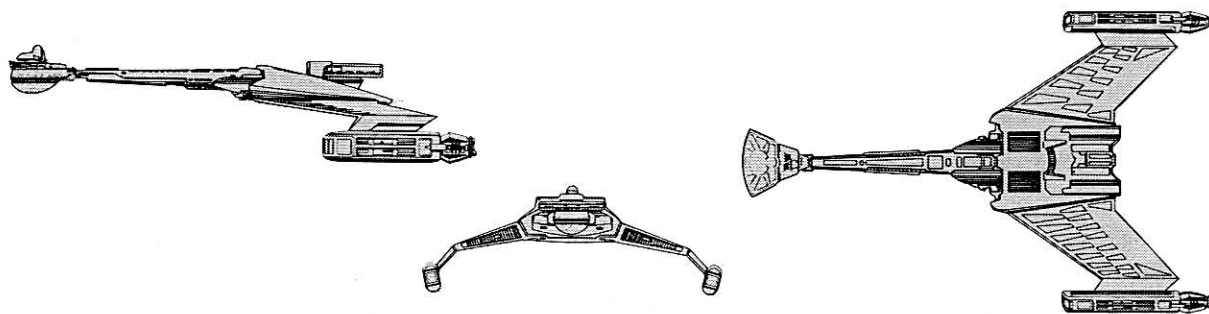

Construction Data:		
Model Numbers —	A	E
Date Entering Service —	1/8407 – 1/9501	1/9203 – 2/0806
Number Constructed —	430	384
Hull Data:		
Superstructure Points —	16	17
Damage Chart —	C	C
Size		
Length —	205 m	205 m
Width —	130 m	130 m
Height —	45 m	45 m
Weight —	82,500 mt	84,600 mt
Cargo		
Cargo Units —	80 SCU	80 SCU
Cargo Capacity —	4,000 mt	4,000 mt
Landing Capability —	None	None
Equipment Data:		
Control Computer Type —	ZD-5	ZD-5
Transporters —		
standard 6-person	3	3
emergency 18-person cargo	1	1
Other Data:		
Crew —	295	305
Shuttlecraft —	4	4
Engines And Power Data:		
Total Power Units Available —	30	34
Movement Point Ratio —	4/1	4/1
Warp Engine Type —	KWC-1	KWC-1
Number —	2	2
Power Units Available —	14	14
Stress Charts —	L/O	L/O
Maximum Safe Cruising Speed —	Warp 7	Warp 7
Emergency Speed —	Warp 8	Warp 8
Impulse Engine Type —	KIB-2	KID-1
Power Units Available —	2	6
Weapons And Firing Data:		
Beam Weapon Type —	KD-2	KD-3
Number —	5	5
Firing Arcs —	2f/p, 2f/s, 1a	2f/p, 2f/s, 1a
Firing Chart —	G	I
Maximum Power —	4	5
Damage Modifiers —		
+1	(1 – 10)	(1 – 12)
Shields Data:		
Deflector Shield Type —	KSB	KSE
Shield Point Ratio —	1/1	1/1
Maximum Shield Power —	6	10
Combat Efficiency:		
D/WDF —	44.9/7.0	53.3/13.5

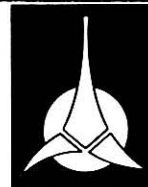

Notes:

Known Sphere Of Operation:
Interior of the Klingon Empire

Data Reliability: A

Major Data Source:

Models A and E are in Star Fleet possession.

The D-4, predecessor to the famed D-7 class, pioneered the command-pod-forward design that has become the standard for most modern Klingon warships. The class was introduced on Stardate 1/8407 with the commissioning of eight ships, which had been produced at the alarming rate of one per month at facilities operating as if under wartime production orders. This was a clear signal that the Klingons were either preparing for a war with either Romulan or Federation forces or were involved in a conflict along an unknown border. Only recently, because of intelligence gained from Operation Dixie, has it come to light that the Klingons were in fact being attacked by an unknown enemy along their coreward border. During this conflict the D-4 saw extensive action and went through several different modifications, several of which were never brought into production. This conflict ended somewhere around Stardate 1/8610, slowing further development.

On Stardate 1/9108, the D-4E was tested and proclaimed successful. Production was converted over to this newer model, and, by Stardate 1/9203, the first vessels were commissioned. By 1/9501, the D-4A was no longer being produced, and most of the D-4As in service were being converted to D-4Es, which mounted a more powerful impulse drive system.

The major improvement was the replacement of the KD-2 by the KD-3, with a range of 120,000 km, extending the offensive capability of the D-4 by 20,000 km. The shielding system was also upgraded, with the new KSE system giving the ship 65% more protection from incoming fire. The superstructure was strengthened to handle the uprated equipment. Even though the D-4 proved to be valuable in combat, witnessed by its class name of "Predator" from the Klingon *d'ama*, its days were numbered. The D-7, with its higher firepower and more powerful engines, would replace it by Stardate 2/0806.

Of the 814 D-4s built, 277 are in reserve fleets (48 As and 229 Es), 462 were destroyed, 14 have been captured (3 As and 6 Es by Star Fleet and 2 As and 3 Es by the Romulans), 6 reported as missing, 16 were scrapped, 11 sold to the Orions (4 As and 7 Es), and 28 sold to prominent families of the Empire (10 As and 18 Es).

D-9 (Seeker) CLASS VIII CRUISER

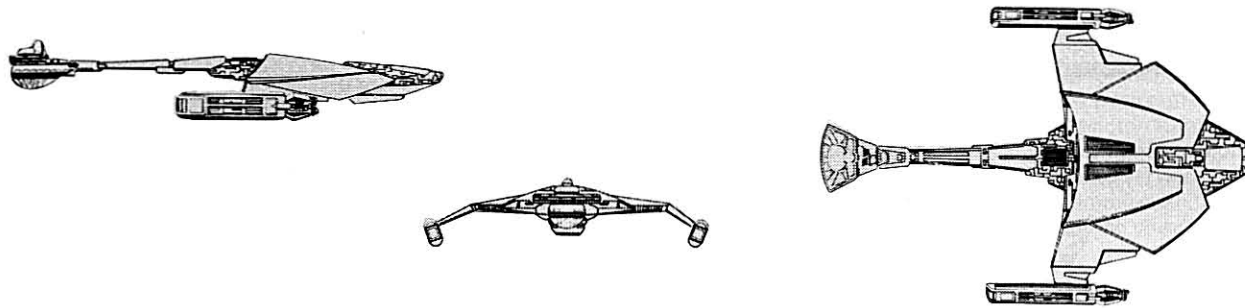

Construction Data:

Model Numbers —	B
Ship Class —	VIII
Date Entering Service —	1/9704
Number Constructed —	82

Hull Data:

Superstructure Points —	20
Damage Chart —	C
Size	
Length —	160 m
Width —	110 m
Height —	24 m
Weight —	100,500 mt
Cargo	
Cargo Units —	100 SCU
Cargo Capacity —	5,000 mt
Landing Capability —	None

Equipment Data:

Control Computer Type —	ZD-5
Transporters —	
standard 6-person	4
emergency 18-person	2
cargo	2

Other Data:

Crew —	380
Passengers —	40
Shuttlecraft —	4

Engines And Power Data:

Total Power Units Available —	38
Movement Point Ratio —	4:1
Warp Engine Type —	KWD-1
Number —	2
Power Units Available —	18
Stress Charts —	L/N
Maximum Safe Cruising Speed —	Warp 6
Emergency Speed —	Warp 8
Impulse Engine Type —	KIB-2
Power Units Available —	2

Weapons And Firing Data:

Beam Weapon Type —	KD-5
Number —	4
Firing Arcs —	1p, 2f, 1s
Firing Chart —	P
Maximum Power —	4
Damage Modifiers —	
+2	(1 - 10)
+1	(11 - 18)
Beam Weapon Type —	KD-4
Number —	1
Firing Arcs —	A
Firing Chart —	J
Maximum Power —	4
Damage Modifiers —	
+1	(1 - 10)

Shields Data:

Deflector Shield Type —	KSF
Shield Point Ratio —	2.3
Maximum Shield Power —	9

Combat Efficiency:

D.WDF —	61.6/14.4
---------	-----------

Notes:

Known Sphere Of Operation:

Spinward and Federation Borders

Data Reliability: C

Major Data Source: Klingon Sector Intelligence

The *D-9* cruiser was brought into service during the Four Years War to act as a research vessel. For years, the Klingon Empire had been halted in its attempts at expansion. To the rimward lay the Federation; towards the trailing arm were the Romulans; and it has been speculated that to the coreward lay some unknown power able to hold the Klingons in check. This left the spinward area, as yet not fully explored. Expansion into this void had been slow due to the great distances from the homeworld of Klinzhai and the apparent lack of suitable worlds for conquest, but the desire to outflank the Federation altered that. The newly constructed *D-9* cruiser was intended to lead this effort.

The *D-9A* prototype was considered to be undergunned and was dropped from production even before it had been commissioned. An upgunned version, the *D-9B* with mainly defensive weaponry, was commissioned on Stardate 1/9704 and was immediately sent into the new expansion area. These ships and their accompanying scoutships were to map new areas and evaluate the cultural levels of any races encountered. The war with the Federation ended one year after the *D-9Bs* entered service, and the sense of urgency for the flanking expansion effort diminished. The flanking movement is portrayed in a Star Fleet commanders test known as *Operation Armageddon*.

After the end of the Four Years War, most of the facilities set up to produce these research cruisers were converted over to warship designs, accounting for the small number produced. The *D-9*, named "Seeker" from the Klingon *z'gal*, is manufactured at Gnuu Re, with production at three per year. These vessels are still operating in the spinward areas. Of the 82 *D-9s* built, 68 remain in active service, 9 have been destroyed, 3 are listed as missing, and 2 have been sold to private interests in the Triangle.

D-10 (Riskadh) CLASS VIII - X CRUISER

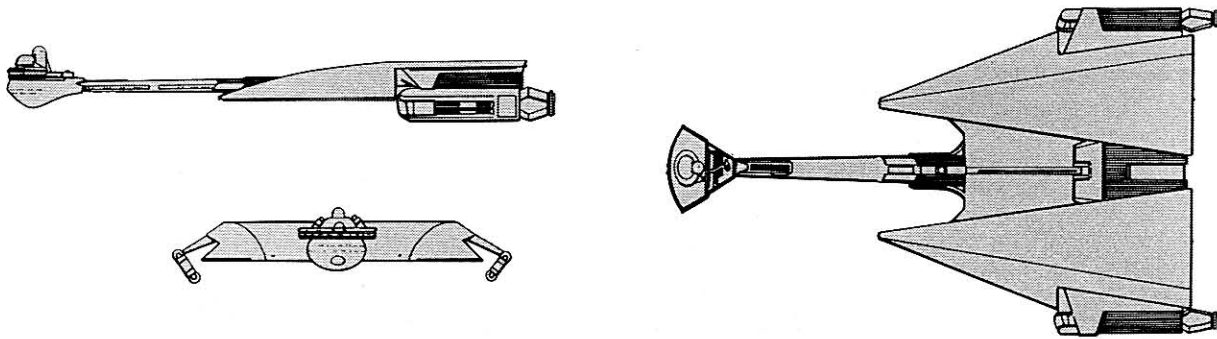

Construction Data:					
<i>Model Numbers —</i>	A	D	F	G	H
<i>Ship Class —</i>	VIII	X	X	X	X
<i>Date Entering Service —</i>	1/9606-2/1801	2/1307	2/1410	2/1601	2/2009
<i>Number Constructed —</i>	444	455	14	84	32
Hull Data:					
<i>Superstructure Points —</i>	22	24	28	28	30
<i>Damage Chart —</i>	C	C	C	C	C
<i>Size</i>					
Length —	262 m	264 m	266 m	264 m	264 m
Width —	157 m	157 m	157 m	157 m	157 m
Height —	30 m	32 m	32 m	30 m	30 m
Weight —	104,800 mt	142,400 mt	143,800 mt	151,510 mt	154,250 mt
<i>Cargo</i>					
Cargo Units —	245 SCU	240 SCU	200 SCU	320 SCU	320 SCU
Cargo Capacity —	12,250 mt	12,000 mt	10,000 mt	16,000 mt	16,000 mt
Landing Capability —	None	None	None	None	None
Equipment Data:					
<i>Control Computer Type —</i>	ZD-5	ZD-6	ZD-7	ZD-7	ZD-7
<i>Transporters —</i>					
standard 6-person	4	4	4	4	4
combat 22-person	6	6	5	5	5
emergency 18-person	1	1	1	4	4
cargo	2	2	2	2	2
Other Data:					
<i>Crew —</i>	505	520	532	525	530
<i>Passengers —</i>				20	20
<i>Troops —</i>	320	320	240	12	12
<i>Shuttlecraft —</i>	10	10	8		
Engines And Power Data:					
<i>Total Power Units Available —</i>	38	40	46	46	52
<i>Movement Point Ratio —</i>	4/1	4/1	4/1	4/1	4/1
<i>Warp Engine Type —</i>	KWD-1	KWE-2	KWE-3	KWE-3	KWE-3
Number —	2	2	2	2	2
Power Units Available —	18	18	20	20	20
Stress Charts —	L/N	J/M	J/M	J/M	J/M
Maximum Safe Cruising Speed —	Warp 6	Warp 7	Warp 7	Warp 7	Warp 7
Emergency Speed —	Warp 8	Warp 8	Warp 8	Warp 8	Warp 8
<i>Impulse Engine Type —</i>	KIB-2	KID-2	KIE-1	KIE-1	KIE-2
Power Units Available —	2	4	6	6	12
Weapons And Firing Data:					
<i>Beam Weapon Type —</i>	KD-6	KD-9	KD-13	KD-13	KD-13
Number —	6	6	8	8	10
Firing Arcs —	2f p, 2f s	2f p, 2f s, 2f s	2f p, 2f, 2f s, 2a	2f p, 2f, 2f s, 2a	2f p, 2f, 2f s, 4a
Firing Chart —	T	W	X	X	X
Maximum Power —	6	5	5	5	5
Damage Modifiers —					
+3		(1 - 8)	(1 - 7)	(1 - 7)	(1 - 7)
+2	(1 - 18)	(8 - 15)	(8 - 15)	(8 - 15)	(8 - 15)
+1		(16 - 22)	(16 - 22)	(16 - 22)	(16 - 22)
<i>Beam Weapon Type —</i>	KD-3	KD-3	KD-5	KD-5	KD-5
Number —	2	2	2	2	2
Firing Arcs —	A	A	A	A	A
Firing Chart —	I	I	P	P	P
Maximum Power —	5	5	4	4	4
Damage Modifiers —					
+2			(1 - 10)	(1 - 10)	(1 - 10)
+1	(1 - 12)	(1 - 12)	(11 - 18)	(11 - 18)	(11 - 18)
<i>Missile Weapon Type —</i>		KP-4	RPL-1	KP-4	KP-6
Number —		2	1	2	2
Firing Arcs —		1f, 1a	F	1f, 1a	1f, 1a
Firing Chart —		Q	E	Q	Q
Power To Arm —		2	10	2	2
Damage —		18	See Chart	18	20
Shields Data:					
<i>Deflector Shield Type —</i>	KSJ	KSO	KSL	KSL	KSL
Shield Point Ratio —	2/3	1/2	1/3	1/3	1/3
Maximum Shield Power —	12	15	14	14	14
<i>D/WDF —</i>	69/36	85.3/45.2	102.5/55.7	107.5/61.6	118.3/68.8

Notes:

Known sphere Of Operation: Empire-wide use

Data Reliability: A for models A, D, and G; B for model F; D for model H.

Major Data Source: Models A, D, and G are in Star Fleet possession; Klingon Sector Intelligence

On Stardate 1/9606, the *D-10* cruiser, the design of which was strongly influenced by the *D-7*, was commissioned into service. The Klingon Imperial Command hoped to counter Star Fleet's *Constitution* class cruisers with this new vessel. The Four Years War was in its second year, and the Klingons had learned some of their lessons well. The *D-10* featured a sturdy superstructure and the most effective shields the empire had to offer. The fore- and aft-mounted disruptors were far superior to the Federation lasers, but were not as destructive as the Federation's accelerator cannons.

The *D-10* used the same command pod as the *D-7*, thus eliminating the need for additional production facilities. Like the *D-7*'s pod, that of the *D-10* is capable of being jettisoned and has similar sub-light maneuvering and life support capabilities. On Stardate 1/9802, Star Fleet captured a pod that had been jettisoned during the Battle of Kesse 16 months earlier; the crew were alive and as well as could be expected.

The main hull of the early *D-10*s contain the engineering section, shuttlebays, crew quarters, and assault troop hypothermia capsules; later models have no troop-carrying capabilities but instead have large research facilities. The warp engines are mounted on short pylons and are jettisonable. With the additional removal of the hypothermia capsules, the ship is capable of running on its impulse power alone for up to one year. The shuttle hangars are located on the upper wing surface of the main hull and are seen as two large doors. Directly aft of these doors are located the aft firing disruptors; aft-firing photon torpedo tubes are located at the stern of the vessel just below the impulse exhaust port.

The *D-10* is the only Klingon warship whose class name honors a Klingon family line: the Riskadh line, which died with its founder, Kahless the Unforgettable, the greatest of all emperors. *D-10*s are manufactured at the Taamar, Gnuu Re', Fonawl, Z'hai, and Mustaka facilities. The combined production rate is 14 *D-10Ds*, 12 *D-10Gs*, and 10 *D-10Hs* per year.

The *D-10A* first entered service on Stardate 1/9606, the first ships being rapidly sent into the Four Years War, where they proved to be the most powerful and feared ships in the Klingon Imperial Navy.

The model used a powerful warp engine, but mounted a fairly weak impulse system, the only real shortcoming of the vessel; the main engines allowed the ships to cruise at Warp 6, with emergency speeds as high as Warp 8. The weapons system consisted of six individually-mounted KD-6 disruptors and two aft-mounted KD-3s, giving the cruiser an offensive range capability 80,000 km greater than Federation warships.

With the Klingons having range superiority, if it had not been for the superior tactics of the Star Fleet commanders, the Four Years War might have turned out much differently. Star Fleet commanders were able to neutralize the range superiority in many cases, however. Klingon tactics were to send a *D-10* with a small escort of three to six destroyers into a system to secure it. Federation commanders would leave the system, making it appear unprotected; they would then return from several different directions and take the unsuspecting Klingons in flanking attacks. This tactic was not always successful, but it did deter the Klingons from mounting many attacks into the interior of Federation space. In the last months of the war, the Klingons faced the newly-developed phaser and photon torpedo, and the days of the *D-10* as the "Queen Of Battle" were over.

Of the 444 *D-10As* built, 27 are in reserve fleets, 268 have been converted to *D* models and 14 to *F* models, 106 have been destroyed, 8 have been captured (6 by Star Fleet and 2 by the Romulans), 6 are listed as missing, 7 have been scrapped, 6 have been sold to ranking families within the

Empire, and 2 have been sold to private interests in the Triangle.

The first modification to the *D-10* came on Stardate 2/1012, when the KIB-2 impulse drive system was replaced with the KID-2. Though the new *D-10B* was ordered into production, it never was produced in numbers because the KWE-2 warp drive system was brought into the navy's inventory just as the new *B* models were ready for installation of their warp drives. These engines were installed, and, on Stardate 2/1201, the first *D-10C* was taken out for maneuver trials. On Stardate 2/1205, the completed ships were outfitted with the newly-created KD-9 disruptors, KP-4 photon torpedo, and the KSO shield systems, replacing the original equipment with upgraded systems. The *D-10D* entered service on Stardate 2/1307 with the simultaneous commissioning of 23 ships, the largest number of new ships to be commissioned at one time in known space.

The KWE-2 warp drive system allows the *D-10D* to achieve cruising speeds of Warp 7 and emergency speeds of Warp 8, even though it adds 30,000 mt to the overall weight. The KD-9 disruptors produce slightly less damage than the KD-6 models found on the *D-10A*, but they have an increased range of 20,000 km. The real increase in weapons power lies in the KP-4 torpedo, which is mounted fore and aft. The addition of so many new systems required an increase in the superstructure strength.

Of the 455 *D-10Ds* built, 389 remain in active service, 2 are used as training vessels, 47 have been destroyed, 2 have been captured by Star Fleet, 6 are listed as missing, 2 have been scrapped, 1 has been traded to the Romulans, 1 sold to the Orions, and 5 are in the service of ranking families of the Empire.

During the years 2/1002 to 2/1410, the Klingons created 5 new warp drive engines, 2 impulse drive systems, 5 new disruptor types, 4 photon torpedo types, 5 shield systems (of which 2 used a trinary power transformer), and 2 powerful computer systems. With all these new systems, the *D-10F*, incorporating many of them, was inevitable; it was commissioned on Stardate 2/1410. The KWE-3 engines produce 10% more power, and the KIE-1 impulse drive systems produce 50% more power than the systems installed on the *D* models, adding maneuverability. On Stardate 2/1312, the Klingons had acquired 14 Romulan plasma weapons of the RPL-1 type, and these weapons also were installed on the *D-10F*, instead of the photon torpedo. The KD-9 disruptors were replaced with KD-13s, increasing the range another 20,000 km, and the aft-firing KD-3s were replaced by 2 KD-9s and 2 KD-5s. The superstructure strength was increased by 16%, and the shields were upgraded.

After the completion of the *D-10F* models, the Klingons continued to use the Z'hai facility to construct *D-10Gs*, with two changes from the *F* model. The hypothermia capsules were removed and the area rebuilt as a laboratory facility, allowing the *D-10G* to act as a research cruiser in hostile areas where lightly-armed ships like the *D-9* could be easily destroyed or damaged if attacked while alone. To further augment weaponry, fore- and aft-firing photon torpedo bays were installed for the KP-4 torpedo.

On Stardate 2/2009, the *D-10H* was commissioned, the first model that has an exterior change. Instead of mounting the old style command pod, the ship mounted the command pod from the *L-9* frigate, making the class easier to identify on visual scan but a more potent adversary. This model mounts the new KIE-2 impulse drive system, giving it more maneuvering power than most ships in either the Romulan Navy or Star Fleet. The disruptors were all refitted to KD-13s, not only to give the vessels a longer range of fire in all directions but also to ease the maintenance chore. The photon torpedo bay was converted to fire the new KP-6, which causes as much damage as any of those employed by Star Fleet and twice the damage as any used by the Romulans. With this array of weapons, and with its strengthened superstructure, the *D-10H* is, by far, the most powerful of the class and also stronger than most others in space.

D-20 (Death Rite) CLASS VII CRUISER

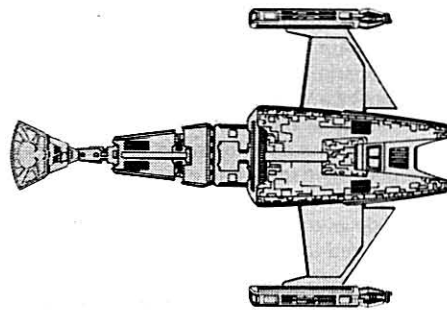
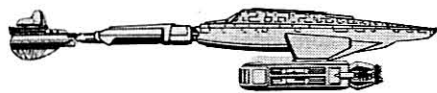

Construction Data:

<i>Model Numbers —</i>	A	C	D
<i>Date Entering Service —</i>	1/9606-2/1603	2/1202	2/1701
<i>Number Constructed —</i>	382	271	87
Hull Data:			
<i>Superstructure Points —</i>	16	18	20
<i>Damage Chart —</i>	C	C	C
Size			
<i>Length —</i>	160 m	160 m	160 m
<i>Width —</i>	110 m	110 m	110 m
<i>Height —</i>	22 m	24 m	24 m
<i>Weight —</i>	85,400 mt	91,300 mt	95,600 mt
Cargo			
<i>Cargo Units —</i>	200 SCU	200 SCU	200 SCU
<i>Cargo Capacity —</i>	10,000 mt	10,000 mt	10,000 mt
<i>Landing Capability —</i>	None	None	None
Equipment Data:			
<i>Control Computer Type —</i>	ZD-5	ZD-6	ZD-6
<i>Transporters —</i>			
<i>standard 6-person</i>	3	3	3
<i>combat 22-person</i>	4	4	4
<i>emergency 18-person</i>	1	1	1
<i>cargo</i>	2	2	2
Other Data:			
<i>Crew —</i>	330	340	340
<i>Troops —</i>	180	200	200
<i>Shuttlecraft —</i>	4	4	4
Engines And Power Data:			
<i>Total Power Units Available —</i>	32	40	40
<i>Movement Point Ratio —</i>	4/1	3/1	3/1
Warp Engine Type —			
<i>Number —</i>	KWC-1	KWC-2	KWC-2
<i>Power Units Available —</i>	2	2	2
<i>Stress Charts —</i>	14	18	18
<i>Maximum Safe Cruising Speed —</i>	LO	LO	LO
<i>Emergency Speed —</i>	Warp 7	Warp 8	Warp 8
<i>Impulse Engine Type —</i>	Warp 8	Warp 9	Warp 9
<i>Power Units Available —</i>	KIC-2	KIC-2	KIC-2
<i>Power Units Available —</i>	4	4	4
Weapons And Firing Data:			
<i>Beam Weapon Type —</i>			
<i>Number —</i>	KD-5	KD-6	KD-8
<i>Firing Arcs —</i>	6	6	6
<i>Firing Chart —</i>	2f p, 1f, 1a, 2f's	2f p, 1f, 1a, 2f's	2f p, 1f, 1a, 2f's
<i>Maximum Power —</i>	P	T	U
<i>Damage Modifiers —</i>	4	6	7
<i>+ 3</i>			(1 - 7)
<i>+ 2</i>	(1 - 10)	(1 - 18)	(8 - 15)
<i>+ 1</i>	(11 - 18)		(16 - 20)
Shields Data:			
<i>Deflector Shield Type —</i>	KSF	KSK	KSO
<i>Shield Point Ratio —</i>	2/3	1/2	1/2
<i>Maximum Shield Power —</i>	9	12	15
Combat Efficiency:			
<i>DWDF —</i>	52.9/18.6	85.7/30.6	86.6/34.2



Notes:

Known Sphere Of Operation: Empire-wide use

Data Reliability: C

Major Data Source: Klingon Sector Intelligence

The *D-20* was commissioned on Stardate 1/9606 and immediately rushed into the Four Years War, where they were used much like the famed *D-7*. Though the class suffered from lack of maneuver power and a relatively weak superstructure, it seemed to make up for these deficiencies in its weapons and shielding. Mounting the KWC-1 engines, the *D-20A* was able to attain higher warp speeds than the *D-7*, but was less maneuverable. Eighty-six have been converted to the *D-20C*.

This fault was corrected with the introduction of the *D-20C* on Stardate 2/1202. This model is far more maneuverable and has more power, as well as a more efficient shielding system and stronger superstructure. Because of its extra power, KD-6 disruptors were added, increasing firepower by 50%. This model is still in production even though the *D-20D* has entered service on Stardate 2/1701, mounting KD-8 disruptors, which deliver 16% more destructive power over a greater distance.

Of the 634 *D-20s* built, 224 *Cs* and 80 *Ds* remain in active service; 292 *As*, 19 *Cs*, and 1 *D* have been destroyed; 2 *As*, 4 *Cs*, and 1 *D* are listed as missing; 1 *C* and 1 *D* have been scrapped; and 2 *As*, 28 *Cs*, and 4 *Ds* are in the service of ranking and prominent families of the Empire. The class is being produced at Gnuu Re' and at H'rez. These facilities were originally set up to refit *A* models to *C* models, but when orders were issued for the production of the *D* model, Imperial Command redesignated both bases as production facilities. They began producing new ships as soon as the last of the older models had been refit. Both facilities combined produce a total of 13 ships per year.

The class is named from "the death of honor," a traditional death rite involving a silver dagger. In this rite, a captive who has fought well is killed with a silver dagger handed down through the family lines. When a family line is broken, the dagger is destroyed after it has been used to eliminate the last family member.

D-32 (Stronger Bird) CLASS VII CRUISER

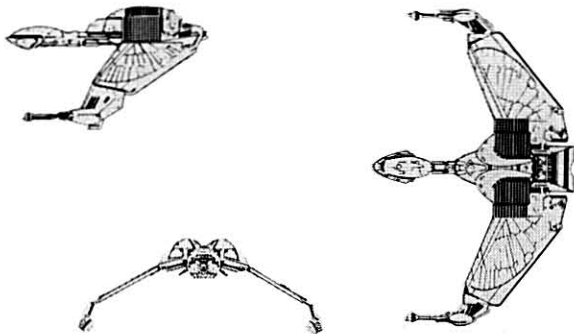

Construction Data:

Model Numbers —	B	C
Ship Class —	VII	VII
Date Entering Service —	2/2004	2/2004
Number Constructed —	22	18

Hull Data:

Superstructure Points —	15	17
Damage Chart —	C	C
Size		
Length —	110 m	110 m
Width —	161 m	161 m
Height —	21 m	21 m
Weight —	83,700 mt	89,300 mt

Cargo

Cargo Units —	30 SCU	30 SCU
Cargo Capacity —	1,500 mt	1,500 mt
Landing Capability —	Yes	Yes

Equipment Data:

Control Computer Type —	ZD-5	ZD-6
Transporters —		
standard 6-person	2	2
emergency 18-person cargo	2	2
cargo	1	1
Cloaking Device Type —	KCC	KCC
Power Requirement —	32	32

Other Data:

Crew —	142	148
Passengers —	5	5
Troops —		
Shuttlecraft —	1	1

Engines And Power Data:

Total Power Units Available —	46	46
Movement Point Ratio —	4.1	4.1
Warp Engine Type —	KWC-1	KWC-1
Number —	2	2
Power Units Available —	14	14
Stress Charts —	LO	LO
Maximum Safe Cruising Speed —	Warp 7	Warp 7
Emergency Speed —	Warp 8	Warp 8
Impulse Engine Type —	KIE-3	KIE-3
Power Units Available —	18	18

Weapons And Firing Data:

Beam Weapon Type —	KD-9	KD-9
Number —	4 in 2 banks of 2	4 in 2 banks of 2
Firing Arcs —	2f p, 2f s	2f p, 2f s
Firing Chart —	W	W
Maximum Power —	5	5
Damage Modifiers —		
+ 3	(1 - 7)	(1 - 7)
+ 2	(8 - 15)	(8 - 15)
+ 1	(16 - 20)	(16 - 20)

Missile Weapon Type —

Number —		RPL-1
Firing Arcs —		F
Firing Chart —		E
Power To Arm —		10
Damage —		See chart
Missile Weapon Type —	KP-5	KP-5
Number —	2	1
Firing Arcs —	1f, 1a	A
Firing Chart —	Q	Q
Power To Arm —	1	1
Damage —	10	10

Shields Data:

Deflector Shield Type —	KSD	KSK
Shield Point Ratio —	1.2	1.2
Maximum Shield Power —	10	13

Combat Efficiency:

DWDF —	68.5/31.0	75.3/29.4
--------	-----------	-----------



Notes:

Known Sphere Of Operation: Empire-wide use

Data Reliability: C for D-32B; D for D-32C

Major Data Source: Klingon Sector Intelligence, Operation Dixie

The *D-32* is one of the newest ships in the Klingon Imperial Navy, the direct result of the latest Klingon-Romulan technology exchange. On Stardate 2/1801, as part of their arrangement, the Romulans supplied the Klingons with seven *S-11* Class V scoutships and the plans to construct them. The Klingons had supplied some of the technology and design for the Romulan *S-11* in the first place, and they were eager to begin construction of these vessels. In fact, they had been secretly planning to produce not only scouts but to enlarge the design to a cruiser and frigate model. While the negotiations were in session, the Klingons were tooling up and producing the pieces for the larger ships, and the compartment that would house the warp and impulse drive systems along with the central wing adjustment mechanism were in production when the treaty was signed.

The most interesting aspect of the *S-11* design is the movable wings, which are positioned straight out for normal cruise, down for attack, and up for atmospheric operation. In the attack mode, the ship presents a smaller target and the disruptors mounted at the wingtips have a better field of fire. In the atmospheric-flight mode, the wings take advantage of the aerodynamic design of the ship, and, in the cruise mode, the wings create a more structurally-sound design that can withstand the forces of high warp speeds. The *D-32* design incorporated these features.

The first cruiser model, the *D-32A*, lacked the maneuverability that the Klingons desired and was modified immediately to the *D-32B*, the first of which was commissioned on Stardate 2/2004, only 18 months after the first *S-11s* were received. The ship mounts a very powerful impulse drive system that delivers 40% of the total maneuver power and gives the ship its ability to perform atmospheric operations. The weaponry is the standard mixture of disruptors and photon torpedoes; the disruptors cover all fields of fire, and the photon torpedoes are mounted both fore and aft.

The *D-32C* is reported to have a Romulan plasma weapon of the RPL-1 type instead of the forward-firing photon bay. It also reputedly uses the KSK shielding system, which is slightly more efficient than KSD installed on the *D-32B*, and the superstructure is thought to be stronger. The KCC Klingon cloaking device is used on both models, but it should prove more effective on the *D-32C* because of the plasma bolt weaponry.

Of the 40 *D-32s* built, 39 remain in active service and 1 has been destroyed. Information obtained from Operation Dixie revealed that the class is produced at H'renn. Undocumented information suggests that Mustaka is being tooled up for production of these vessels.

The class name is from the Klingon *z'gavva*, which translates to "stronger bird".

D-2 (Stingtongue) CLASS VI DESTROYER

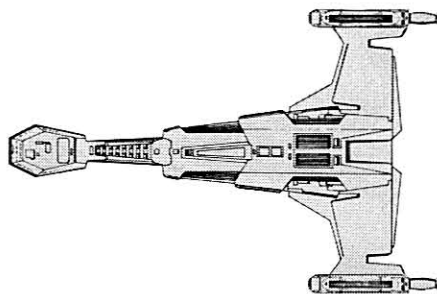
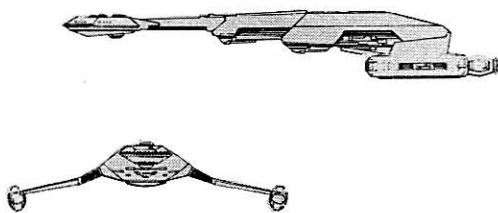

Construction Data:

Model Numbers—	A	B
Date Entering Service—	2/1201	2/1206
Number Constructed—	146	144

Hull Data:

Superstructure Points—	10	10
Damage Chart—	C	C
Size		
Length—	205 m	205 m
Width—	135 m	135 m
Height—	30 m	30 m
Weight—	74,500 mt	74,500 mt

Cargo

Cargo Units—	30 SCU	30 SCU
Cargo Capacity—	1,500 mt	1,500 mt
Landing Capability—	None	None

Equipment Data:

Control Computer Type—	ZD-5	ZD-5
Transporters—		
standard 6-person	2	2
emergency 18-person	2	2
cargo	1	1

Other Data:

Crew—	220	220
Passengers—	10	10
Shuttlecraft—	1	1

Engines And Power Data:

Total Power Units Available—	34	34
Movement Point Ratio—	3/1	3/1
Warp Engine Type—	KWC-1	KWC-1
Number—	2	2
Power Units Available—	14	14
Stress Charts—	L/O	L/O
Maximum Safe Cruising Speed—	Warp 7	Warp 7
Emergency Speed—	Warp 8	Warp 8
Impulse Engine Type—	KID-1	KID-1
Power Units Available—	6	6

Weapons And Firing Data:

Beam Weapon Type—	KD-6	KD-6
Number—	2	2
Firing Arcs—	1f/p/s, 1a/p/s	1f/p/s, 1a/p/s
Firing Chart—	T	T
Maximum Power—	6	6
Damage Modifiers—		
+ 2	(1 - 18)	(1 - 18)
Missile Weapon Type—	KP-2	KP-2
Number—	4	4
Firing Arcs—	2f, 2a	4f
Firing Chart—	H	H
Power To Arm—	1	1
Damage—	10	10

Shields Data:

Deflector Shield Type—	KSN	KSN
Shield Point Ratio—	2/3	2/3
Maximum Shield Power—	15	15

Combat Efficiency:

D/WDF—	69.3/23.4	69.3/23.4
--------	-----------	-----------



Notes:

Known Sphere Of Operation: Empire-wide use

Data Reliability: A for D-2A; C for D-2B

Major Data Source: D-2A in Star Fleet possession; Klingon Sector Intelligence

Shortly after the discovery of photon technology, the Klingon Imperial Navy initiated a program for a missile-armed destroyer. Several designs were reviewed and tested before the D-2A was commissioned on Stardate 2/1201. Five months later, the D-2B entered service, different only in the arrangement of its torpedo bays. The D-2 is an excellent offensive weapon against ships of its own class, but it is not able to hold its own against larger ships due to the lack of range its torpedoes have and a relatively weak superstructure.

These missile boats mount KWC-1 warp engines, which gives them good tactical maneuverability. Each mounts two KD-6 disruptors covering all areas of fire as well as four KP-2 photon torpedoes. The D-2A's torpedo bays are split evenly forward and aft, allowing it to close with and pass through the enemy's formation, firing torpedoes into usually unprotected aft areas. All the D-2B's torpedo bays are mounted forward, giving a tremendous amount of punch from the front but none from the rear.

Of the 290 D-2s built, 128 As and 135 Bs remain in active service; 12 As and 8 Bs have been destroyed; 1 B has been captured by the Romulans; 2 As are listed as missing; 1 A has been scrapped; and 2 As are in the service of prominent families of the Empire. The D-2 class is produced at Iosia and H'renn. Intelligence estimates these facilities produce a combined average of twelve of each type per month.

The class is named from the Klingon *v'kar zadan*, which translates to "the tongue that stings".

D-11 (One Wing) CLASS VI - VII DESTROYER

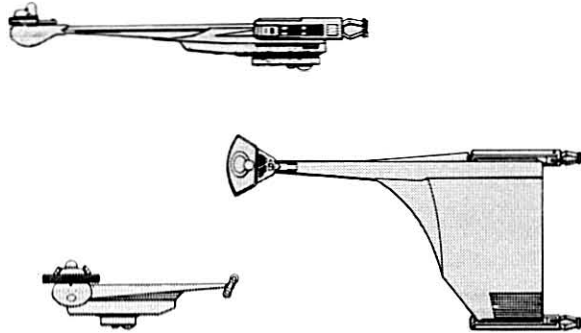

Notes:

Known Sphere Of Operation: Empire-wide use

Data Reliability: B

Major Data Source: Klingon Sector Intelligence, Triangle Sector Intelligence

The *D-11* destroyer is the most unusual design in the Klingon Imperial Navy, easily recognized on visual scan because of its one wing. It was commissioned into the service on Stardate 2/0405. That the vessel never fared well in battle has been blamed on its asymmetrical design, which worked to restrict the field of fire from the weapon mounting hardpoints.

Powered by the KWC-1 and able to travel at speeds of Warp 7, it was one of the fastest ships in known space at the time it was commissioned, as well as having satisfactory tactical maneuverability. Nevertheless, the first *D-11s* were unpopular with the crews for they lacked sufficient firepower to perform their duties. It is not surprising then that a weaponry modification was made in the *D-11C*, in which the KD-4s were replaced with KD-5s and the new KD-10 was added. Although this extended the offensive range by 80,000 km, the *D-11's* performance in battle was not significantly improved.

The *D-11D* used the KWC-2 warp engine, increasing the warp speeds attainable. It also mounted the new photon torpedo, which gave it more destructive firepower in a limited range but did little to improve battle performance overall.

Due to its problems and the success of other destroyer designs, the mission of the *D-11* has been changed. These vessels are now used for light assault duties. Having the capacity to carry a company of marines, the *D-11s* are used to secure lightly-held systems. They also have been reported to be accompanying the *D-9* research cruisers in their efforts to open new territories.

Of the 354 *D-11s* built, 106 *Cs* and 41 *Ds* remain in active service; 68 *Bs*, 39 *Cs* and 18 *Ds* have been destroyed; 1 *D* has been captured by the Romulans; 11 *Bs* and 2 *Cs* are listed as missing; 19 *Bs* and 4 *Cs* have been scrapped; 6 *Bs*, 2 *Cs*, and 2 *Ds* have been sold to the Orions; and 12 *As* have been sold to private interests in the Triangle. The *D-11* is no longer under production; it was manufactured at Taamar and H'renn.

The class name of "One Wing" and its nickname of "The One-Armed Bandit" derive obviously from its design, as well as from the Klingon *dath d'lan*. Many jokes circulate through Star Fleet concerning the design. The most long-lived of these has it that the designer was under pressure to have the design completed by a certain date. In order to satisfy his contract and spare his life, goes the story, the manufacturer completed the ship minus the starboard wing assembly.

Construction Data:

Model Numbers —	B	C	D
Ship Class —	VI	VII	VII
Date Entering Service —	2/0405 - 2/1804	2/0811	2/1201
Number Constructed —	140	153	61

Hull Data:

Superstructure Points —	14	14	15
Damage Chart —	C	C	C
Size			
Length —	234 m	234 m	234 m
Width —	128 m	128 m	128 m
Height —	34 m	34 m	45 m
Weight —	79,900 mt	80,500 mt	85,000 mt

Cargo

Cargo Units —	120 SCU	120 SCU	120 SCU
Cargo Capacity —	6,000 mt	6,000 mt	6,000 mt
Landing Capability —	None	None	None

Equipment Data:

Control Computer Type —	ZD-5	ZD-5	ZD-6
Transporters —			
standard 6-person	2	2	2
combat 22-person	2	2	2
emergency 18-person	2	2	2
cargo	1	1	1

Other Data:

Crew —	218	218	225
Passengers —	220	220	220
Shuttlecraft —	2	2	3

Engines And Power Data:

Total Power Units Available —	32	32	40
Movement Point Ratio —	3:1	3:1	3:1
Warp Engine Type —	KWC-1	KWC-1	KWC-2
Number —	2	2	2
Power Units Available —	14	14	18
Stress Charts —	L/O	L/O	L/O
Maximum Safe Cruising Speed —	Warp 7	Warp 7	Warp 8
Emergency Speed —	Warp 8	Warp 8	Warp 9
Impulse Engine Type —	KIC-2	KIC-2	KIC-2
Power Units Available —	4	4	4

Weapons And Firing Data:

Beam Weapon Type —	KD-4	KD-5	KD-9
Number —	2	2	2
Firing Arcs —	1f p, 1a's	1f p, 1a's	1f p, 1a's
Firing Chart —	J	P	W
Maximum Power —	4	4	5
Damage Modifiers —			
+ 3			(1 - 7)
+ 2		(1 - 10)	(8 - 15)
+ 1	(1 - 10)	(11 - 18)	(16 - 20)
Beam Weapon Type —		KD-10	KD-11
Number —		1	1
Firing Arcs —		F	F
Firing Chart —		C	F
Maximum Power —		3	5
Damage Modifiers —			
+ 2			(1 - 4)
+ 1		(1 - 6)	(5 - 8)
Missile Weapon Type —			KP-1
Number —			2
Firing Arcs —			1f, 1a
Firing Chart —			F
Power To Arm —			1
Damage —			6

Shields Data:

Deflector Shield Type —	KSJ	KSJ	KSJ
Shield Point Ratio —	2:3	2:3	2:3
Maximum Shield Power —	13	13	13

Combat Efficiency:

DWDF —	60.9.4	60.9.6.9	68.5.13.2
--------	--------	----------	-----------

D-14 (Stinger) CLASS VI DESTROYER

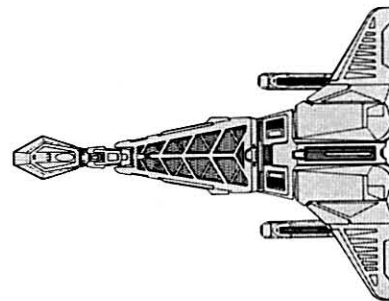

Construction Data:

Model Numbers —	A	B
Ship Class —	VI	VI
Date Entering Service —	2/1607	2/2008
Number Constructed —	142	66

Hull Data:

Superstructure Points —	15	15
Damage Chart —	C	C
Size		
Length —	220 m	220 m
Width —	170 m	170 m
Height —	42 m	42 m
Weight —	59,800 mt	60,100 mt

Cargo

Cargo Units —	80 SCU	80 SCU
Cargo Capacity —	4,000 mt	4,000 mt
Landing Capability —	None	None

Equipment Data:

Control Computer Type —	ZD-5	ZD-5
Transporters —		
standard 6-person	2	3
emergency 18-person	2	2
cargo	1	1
Cloaking Device Type —	None	KCB
Power Requirement —		22

Other Data:

Crew —	285	292
Passengers —	30	30
Shuttlecraft —	2	2

Engines And Power Data:

Total Power Units Available —	40	40
Movement Point Ratio —	3:1	3:1
Warp Engine Type —	KWC-3	KWC-3
Number —	1	1
Power Units Available —	22	22
Stress Charts —	L/M	L/M
Maximum Safe Cruising Speed —	Warp 6	Warp 6
Emergency Speed —	Warp 7	Warp 7
Impulse Engine Type —	KIE-3	KIE-3
Power Units Available —	18	18

Weapons And Firing Data:

Beam Weapon Type —	KD-6	KD-6
Number —	4	4
Firing Arcs —	1p/a, 2f/p/s, 1s/a	1p/a, 2f/p/s, 1s/a
Firing Chart —	T	T
Maximum Power —	6	6
Damage Modifiers —		
+2	(1 - 18)	(1 - 18)
Missile Weapon Type —	KP-1	KP-2
Number —	2	2
Firing Arcs —	1f, 1a	1f, 1a
Firing Chart —	F	H
Power To Arm —	1	1
Damage —	6	10

Shields Data:

Deflector Shield Type —	KSG	KSG
Shield Point Ratio —	1/2	1/2
Maximum Shield Power —	11	11

Combat Efficiency:

D.WDF —	74.5/23.4	74.5/27.0
---------	-----------	-----------



Notes:

Known Sphere Of Operation:

Federation and Triangle Borders

Data Reliability: C

Major Data Source: Triangle Sector Intelligence

Two models of this destroyer have been produced. Twelve *D-14Bs* are equipped with the KCB cloaking device. The class name, from the Klingon *d'esta kar*, refers to a predator on the planet Nogunda; this creature immobilizes its prey by injecting a paralyzing agent through its stinger.

Of the 208 *D-14s* built, 119 *As* and 61 *Bs* remain in active service; 20 *As* and 1 *B* have been destroyed; 2 *As* and 1 *B* have been listed as missing; and 1 *B* has been traded to the Romulans, 1 *A* has been sold to the Orions, and 2 *Bs* have been sold to private interests in the Triangle. The *D-14* is under production at Taamar, H'renn, and Fonawl. The combined annual rate is 20 of each type.



D-16 (Swiftwind) CLASS VI DESTROYER

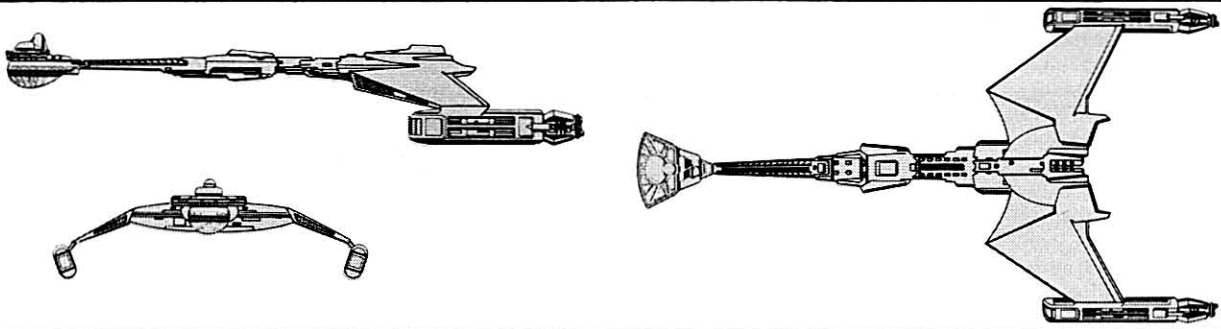

Construction Data:

Model Numbers —	A
Ship Class —	VI
Date Entering Service —	1/8805 – 2/1001
Number Constructed —	192

Hull Data:

Superstructure Points —	8
Damage Chart —	C
Size	
Length —	190 m
Width —	100 m
Height —	28 m
Weight —	70,800 mt

Cargo

Cargo Units —	30 SCU
Cargo Capacity —	1,500 mt
Landing Capability —	None

Equipment Data:

Control Computer Type —	ZD-5
Transporters —	
standard 6-person	2
emergency 18-person	1
cargo	1

Other Data:

Crew —	180
Passengers —	10
Shuttlecraft —	1

Engines And Power Data:

Total Power Units Available —	30
Movement Point Ratio —	3/1
Warp Engine Type —	KWC-1
Number —	2
Power Units Available —	14
Stress Charts —	L/O
Maximum Safe Cruising Speed —	Warp 7
Emergency Speed —	Warp 8
Impulse Engine Type —	KIB-2
Power Units Available —	2

Weapons And Firing Data:

Beam Weapon Type —	KD-2
Number —	4
Firing Arcs —	3f/p/s, 1a
Firing Chart —	G
Maximum Power —	4
Damage Modifiers —	
+1	(1 – 10)

Shields Data:

Deflector Shield Type —	KSC
Shield Point Ratio —	1/1
Maximum Shield Power —	9

Combat Efficiency:

D/WDF —	38.4/5.6
---------	----------



Notes:

Known Sphere Of Operation: Interior of Klingon Empire
Data Reliability: A

Major Data Source: In possession of Star Fleet

Of the 192 *D-16s* built, 27 are in reserve fleets, 123 have been destroyed, 11 have been captured (6 by Star Fleet, 4 by Romulans and 1 by Orions), 8 are listed as missing, 3 have been scrapped, 16 have been sold to ranking and prominent families in the Empire, and 4 have been sold to private interests within the Triangle. The *D-16*, named from the Klingon *kl'sarza*, was produced at Iosia.



D-18 (Gull) CLASS VII - IX DESTROYER

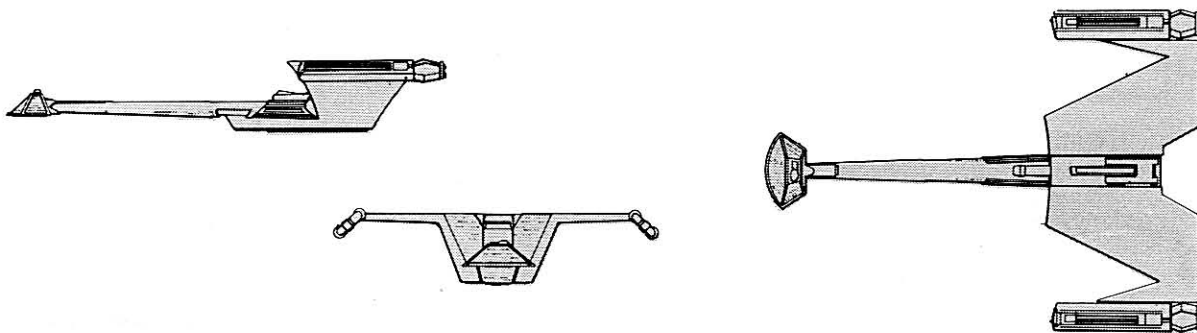

Construction Data:

Model Numbers —	A	B	C
Ship Class —	VII	IX	IX
Date Entering Service —	2/0108-2/1512	2/1110	2/1803
Number Constructed —	231	358	82

Hull Data:

Superstructure Points —	14	14	14
Damage Chart —	C	C	C
Size			
Length —	215 m	212 m	212 m
Width —	159 m	159 m	159 m
Height —	38 m	38 m	38 m
Weight —	90,500 mt	125,500 mt	125,800 mt
Cargo			
Cargo Units —	65 SCU	70 SCU	70 SCU
Cargo Capacity —	3,250 mt	3,500 mt	3,500 mt
Landing Capability —	None	None	None

Equipment Data:

Control Computer Type —	ZD-5	ZD-6	ZD-6
Transporters —			
standard 6-person	2	2	2
emergency 18-person	2	2	2
cargo	1	1	1
Cloaking Device Type —	None	None	KCC
Power Requirement —			32

Other Data:

Crew —	265	265	280
Passengers —	20	20	20
Shuttlecraft —	12	12	12

Engines And Power Data:

Total Power Units Available —	38	42	42
Movement Point Ratio —	4/1	3/1	3/1
Warp Engine Type —	KWD-1	KWE-3	KWE-3
Number —	2	2	2
Power Units Available —	18	20	20
Stress Charts —	L/N	J/M	J/M
Maximum Safe Cruising Speed —	Warp 6	Warp 8	Warp 8
Emergency Speed —	Warp 8	Warp 9	Warp 9
Impulse Engine Type —	KIB-2	KIB-2	KIB-2
Power Units Available —	2	2	2

Weapons And Firing Data:

Beam Weapon Type —	KD-5	KD-5	KD-5
Number —	2	6	6
Firing Arcs —	1f/p, 1f/s	2f/p, 2f, 2f/s	2f/p, 2f, 2f/s
Firing Chart —	P	P	P
Maximum Power —	4	4	4
Damage Modifiers —			
+2	(1 - 10)	(1 - 10)	(1 - 10)
+1	(11 - 18)	(11 - 18)	(11 - 18)
Beam Weapon Type —	KD-14	KD-14	KD-14
Number —	1	1	1
Firing Arcs —	A	A	A
Firing Chart —	D	D	D
Maximum Power —	8	8	8
Damage Modifiers —			
+2	(1 - 6)	(1 - 6)	(1 - 6)
Missile Weapon Type —			KP-5
Number —			1
Firing Arcs —			A
Firing Chart —			Q
Power To Arm —			1
Damage —			10

Shields Data:

Deflector Shield Type —	KSE	KSE	KSD
Shield Point Ratio —	1/1	1/1	1/2
Maximum Shield Power —	10	8	8

Combat Efficiency:

D/WDF —	47.5/8.3	54.0/20.7	71.0/26.2
---------	----------	-----------	-----------

Notes:

Known Sphere Of Operation: Empire-wide use
Data Reliability: A for *D-18A* and *D-18B*; C for *D-18C*

Major Data Source: A and B models in Star Fleet possession;
Klingon Sector Intelligence

The *D-18*, by far the most widely-used destroyer in the Klingon Imperial Navy, is found in every region of Klingon space and in the Triangle. There are even reports of *D-18* groups accompanying research efforts in the spinward areas.

Like other Klingon vessels, the *D-18* has the command pod forward of the main hull, though the boom or neck is considerably smaller than on other designs. The thin neck has no storage compartments or uses other than to contain a horizontal turbolift. The pod has jettison mechanism coupled with a small impulse drive system, but, unlike other self-contained pods, it contains no weapons. All the bridge crew quarters are located in the pod, as are food synthesizers and life-support systems.

The main hull of the *D-18* is very large and spacious, featuring the very effective compartmented design to reduce decompressive explosion in case of penetration. The warp drives are mounted at the outer edge of the wings, giving the ship a gull-wing appearance and its nickname. The warp engines may be jettisoned in case of an overload, leaving the hull to operate with its impulse drive system located center-aft. Inside the hull, forward of the impulse drive, is the engineering section for the entire ship, occupying a roomy eight decks. Forward of engineering, in the center-forward area of the main hull just above the connecting point for the boom, is the impressive shuttle bay, containing space for twelve shuttlecraft, more than most major warships. The beam weapons are mounted on the underside of the main hull, with the forward-firing KD-5s at the corners and center of the hull and the aft-firing KD-14 centrally mounted; in later models, the KD-14 is mounted on the bottom of the torpedo bay.

The Klingons call the class *Lara'atan*, which translates to "protector of brothers". The class is more commonly referred to as "Gull" by Star Fleet personnel, an obvious reference to its appearance.

When the *D-18A* entered service on Stardate 2/0108, the military situation along all borders was relatively calm. The Klingons, still recovering from the war with the Federation, did not wish to antagonize Star Fleet any more than necessary, so the first groups of *D-18As* were placed along the Romulan and Triangle borders. For three years, the *D-18As* performed patrol duties without incident.

In the ship's first combat test, three *D-18s* were ordered into the Triangle to intercept a Romulan convoy and destroy the transports. Intelligence reports had shown that there would be an escort of only one ship, a new *R-4* about which nothing was known. The *D-18s* approached the convoy from three different directions, hoping to catch the escort with flanking fire and dispatch it easily. The *R-4* was not alone, however, but was accompanied by another *R-4*. The Klingons began firing as soon as they were in range. In response, the Romulans concentrated all fire on first one of the *D-18s* and then another, doing heavy damage. The Klingon captains realized that their ships were underpowered and under-gunned for this type of mission, and began a fighting withdrawal; one survived.

This engagement showed the Imperial Command that the *D-18* needed more efficient engines and a better array of weapons. As originally designed, the pod on the *D-18A* did carry beam weapons, but, by Stardate 2/1512, all of the old *A* models had been converted to *Bs*.

Of the 231 *D-18As* built, 156 have been converted to *Bs*, 62 have been destroyed, 4 (3 by the Romulans and 1 by Star Fleet) have been captured, 2 are listed as missing, 3 have been scrapped, and 3 have been sold to private interests in the Triangle.

The *D-18B* and later models have command pods with an angular appearance and no weaponry. In addition, the *D-18B* mounts the highly efficient KWE-3 warp drive system, giving cruising speeds of Warp 8 and emergency speeds of Warp 9, making the *D-18B* one of the fastest ships in known space, and providing more maneuverability and more power to the weapons systems. The addition of four more KD-5 disruptors gives this model the firepower lacking in the *D18A*. The only drawback of this model is that when the additional engine mass was added, the effectiveness of the shield generators decreased.

The *D-18B*, the most common model to be encountered, has served the Klingon Imperial Navy well and has been involved in many encounters both with the Federation and Romulans. The most notable of these is "The Kargon Incident". In this skirmish, Captain Kresz sutai Kargon, commanding a group of six *D-18Bs*, attacked a Federation outpost located in the Orion sector. Responding to the outpost's distress call was the *USS Kongo* (a *Constitution* class cruiser) accompanied by the *USS Halk* and *USS Rome* (both *Loknar* class frigates). The Federation ships arrived too late to save the outpost, but not too late to engage the Klingons. Detecting only three ships on sensors, one with severe damage and the others with minor damage, Captain J.C. Fredriksen of the *Kongo* ordered the *Loknars* to close with the Klingons and demand their surrender.

In the meantime, the *Kongo* approached the *D-18* lying dead in space. As the *Kongo* neared the vessel, sensors picked up three ships coming out of warp to the rear and the systems aboard the dead ship coming to life. Captain Fredriksen ordered the Helmsman to turn hard about, but it was too late. The damaged *D-18* destructed with such tremendous force that the *Kongo's* starboard warp nacelle was ripped from the hull and the port engine damaged beyond repair. The incoming *D-18s* fired into the burning wreck of the *Kongo* and completed the deed their comrades had begun. The *Halk* was so taken by surprise that it, too, never had a chance to return fire, and the first volley of shots from the oncoming *D-18s* totally destroyed the frigate. The *Rome*, however, opened fire on one of the disabled *D-18s* and scored two photon torpedo hits on its bridge and numerous phaser hits to its engines. The *Rome* then turned on the other disabled *D-18* and began firing as fast as it could, scoring hits with every shot. The *D-18s* rushing in from their attack on the *Halk* fired in unison, and the *Rome*, though it had fought valiantly, suffered the same fate as the other two Star Fleet vessels. News of this attack reached Star Fleet three days later when a communications marker from the *Rome* was retrieved. From this report, it was also learned that the Klingon ships in this engagement were painted in bright blue colors. Ships of this description have been seen in and near the Triangle. Whether they are the ships of Captain Kresz sutai Kargon is unknown.

Of the 358 *D-18Bs* built, 257 remain in active service, 2 are used as training vessels, 82 have been destroyed, 9 have been captured (5 by Star Fleet and 4 by the Romulans), 4 are listed as missing, 1 has been scrapped, and 3 are in the service of ranking families in the Empire. The *D-18B* is currently being produced at the construction facilities located at H'renn and losia. These facilities have an average production rate of 20 ships per year.

The *D-18C* has an aft-firing photon torpedo, added to cover the weak spot of the ship. It also mounts a KSD shield generator, which has a binary transformer that produces shielding at twice the level of efficiency as the KSE system found on the *D-18B*.

Of the 82 *D-18Cs* built, 75 remain in active service, 4 have been destroyed, 1 is listed as missing, and 2 have been sold to private interests in the Triangle. The *D-18C* is currently being produced at Taamar, Fonawl, and Mustaka. Information received from Operation Dixie indicates that these facilities have a combined production rate of 18 per year.

K-23 (Little Killer) CLASS VI - VIII ESCORT

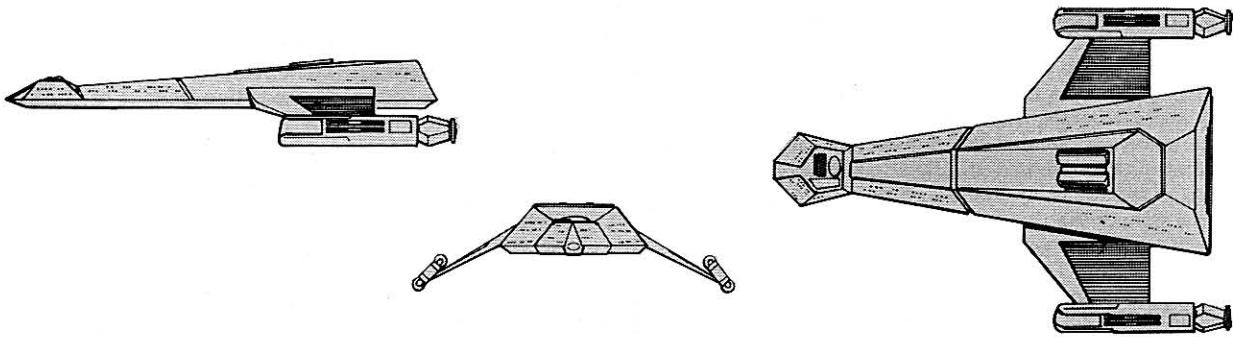

Construction Data:

<i>Model Numbers —</i>	A	B	D	E	F
<i>Ship Class —</i>	VI	VII	VII	VII	VII
<i>Date Entering Service —</i>	1/9702-2/0501	2/0101-2/1601	2/1403	2/1606	2/1808
<i>Number Constructed —</i>	186	332	461	166	101

Hull Data:

<i>Superstructure Points —</i>	12	12	14	14	16
<i>Damage Chart —</i>	C	C	C	C	C
<i>Size</i>					
Length —	194 m	194 m	194 m	194 m	194 m
Width —	138 m	138 m	138 m	138 m	138 m
Height —	38 m	38 m	38 m	38 m	38 m
Weight —	77,250 mt	87,300 mt	90,400 mt	90,500 mt	95,800 mt
<i>Cargo</i>					
Cargo Units —	45 SCU	45 SCU	45 SCU	45 SCU	45 SCU
Cargo Capacity —	2,250 mt	2,250 mt	2,250 mt	2,250 mt	2,250 mt
Landing Capability —	None	None	None	None	None

Equipment Data:

<i>Control Computer Type —</i>	ZD-5	ZD-5	ZD-5	ZD-5	ZD-5
<i>Transporters —</i>					
standard 6-person cargo	1	1	1	1	1
	1	1	1	1	1

Other Data:

<i>Crew —</i>	170	175	175	175	175
<i>Passengers —</i>	15	15	15	15	15
<i>Shuttlecraft —</i>	2	2	2	2	2

Engines And Power Data:

<i>Total Power Units Available —</i>	32	40	40	40	42
<i>Movement Point Ratio —</i>	4/1	4/1	4/1	4/1	4/1
<i>Warp Engine Type —</i>	KWC-2	KWD-1	KWD-1	KWD-1	KWD-1
Number —	2	2	2	2	2
Power Units Available —	14	18	18	18	18
Stress Charts —	L/O	L/N	L/N	L/N	L/N
Maximum Safe Cruising Speed —	Warp 7	Warp 6	Warp 6	Warp 6	Warp 6
Emergency Speed —	Warp 8	Warp 8	Warp 8	Warp 8	Warp 8
<i>Impulse Engine Type —</i>	KIC-2	KIC-2	KIC-2	KIC-2	KID-1
Power Units Available —	4	4	4	4	6

Weapons And Firing Data:

<i>Beam Weapon Type —</i>	KD-4	KD-4	KD-4	KD-13	KD-9
Number —	3	3	2	3 1 bank of 2	6 1 bank of 2
Firing Arcs —	1f/p, 1f, 1f/s	1f/p, 1f, 1f/s	1f/p, 1f/s	2f/p/s, 1f	2f/p/s, 2f, 2a
Firing Chart —	J	J	J	X	W
Maximum Power —	4	4	4	5	5
Damage Modifiers —				(1 - 9)	(1 - 7)
+ 3				(10 - 15)	(8 - 15)
+ 2				(16 - 22)	(16 - 22)
+ 1	(1 - 10)	(1 - 10)	(1 - 10)		
<i>Beam Weapon Type —</i>			KD-13		
Number —			1		
Firing Arcs —			F		
Firing Chart —			X		
Maximum Power —			5		
Damage Modifiers —					
+ 3			(1 - 8)		
+ 2			(9 - 15)		
+ 1			(16 - 22)		

Shields Data:

<i>Deflector Shield Type —</i>	KSE	KSI	KSF	KSF	KSK
Shield Point Ratio —	1/1	1/1	2/3	2/3	1/2
Maximum Shield Power —	10	12	10	10	13

Combat Efficiency:

<i>D/WDF —</i>	39.8/6	48.7/6	56.0/9.7	56.0/17.1	71.9/30
----------------	--------	--------	----------	-----------	---------

Time Line Of Active Service Duty

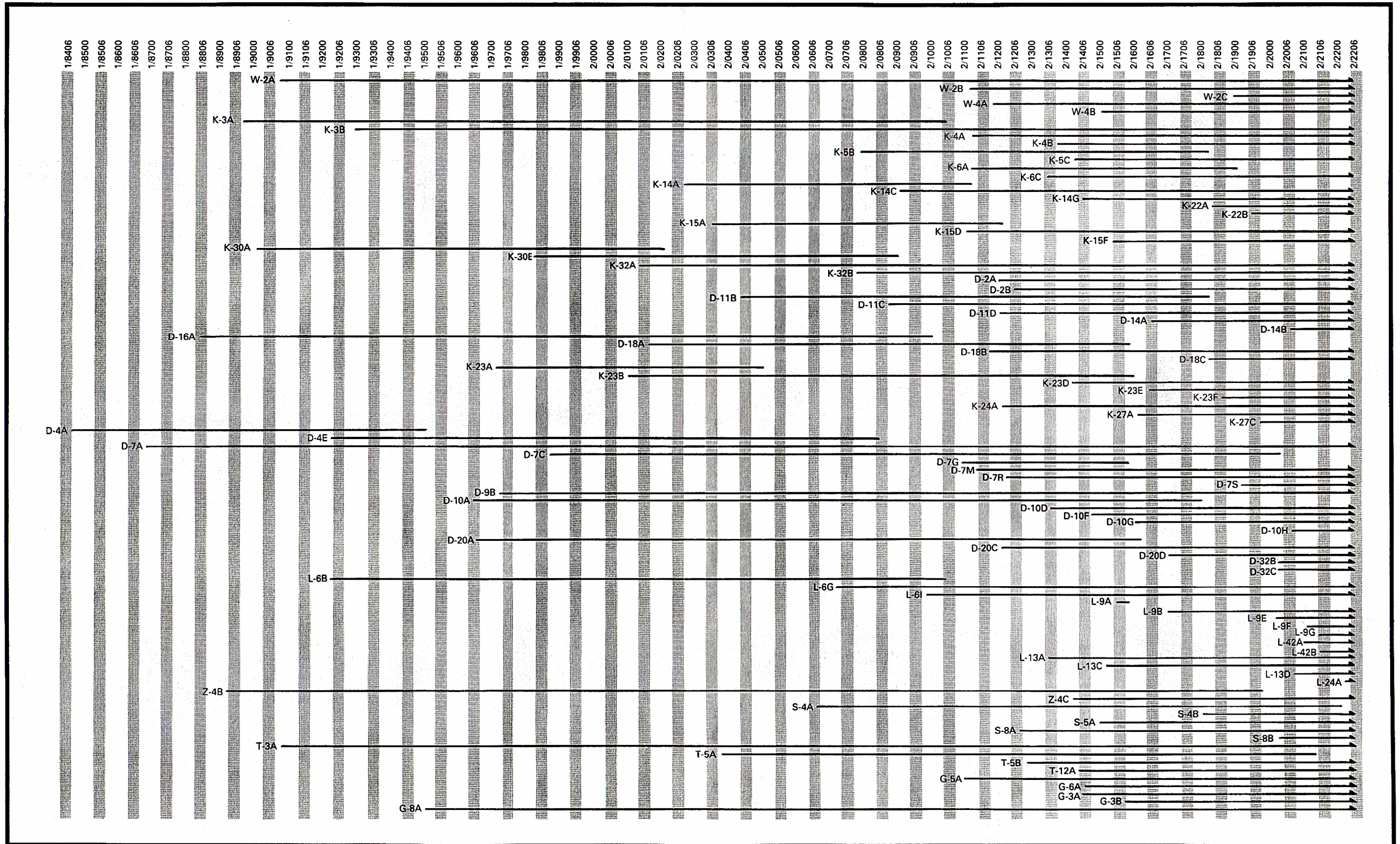

Klingon Recognition Silhouettes



T-12 (Carrier Of Doom)
CLASS IX ASSAULT SHIP

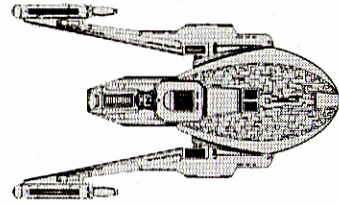

D-9 (Seeker)
CLASS VIII CRUISER

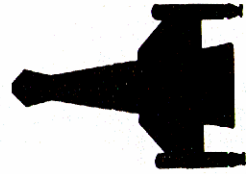

K-23 (Little Killer)
CLASS VI-VIII ESCORT



W-4 (Speedster)
CLASS III WARPSHUTTLE

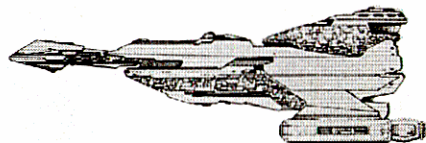

L-24 (Ever-Victorious)
CLASS XIII BATTLESHIP

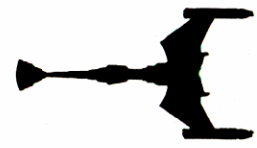
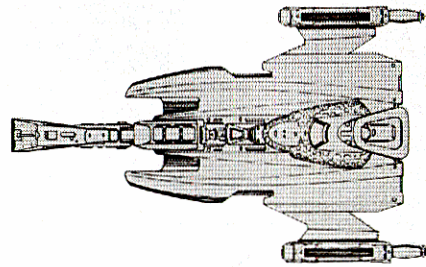

D-16 (Swiftwind)
CLASS VI DESTROYER



D-14 (Stinger)
CLASS VI DESTROYER



K-15 (Unseen Creeper)
CLASS IV-V SCOUT



T-5 (Throne Seeker)
CLASS VII ASSAULT SHIP

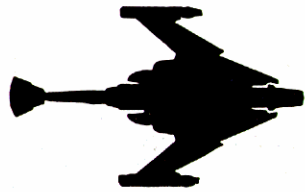
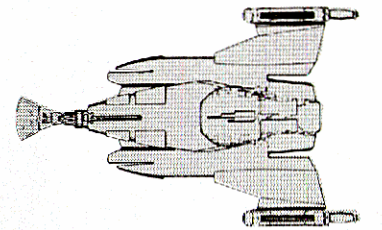

T-3 (Mover)
CLASS VI ASSAULT SHIP



K-22 (Bird Of Prey)
CLASS V SCOUT



D-32 (Stronger Bird)
CLASS VII CRUISER

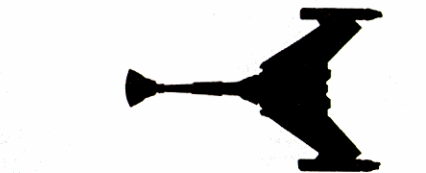

D-4 (Predator)
CLASS VII CRUISER



K-32 (Strong Victor)
CLASS IV MONITOR

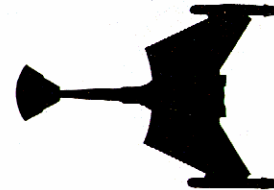

D-7 (Various Names)
CLASS VII-IX CRUISER

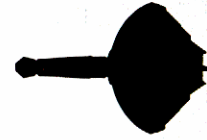

K-27 (Grim Reaper)
CLASS VI ESCORT



G-3 (Baka Re')
CLASS VII-VIII CARGO FREIGHTER



W-2 (Koreba)
CLASS II-III WARPSHUTTLE



L-6 (Defender)
CLASS VIII-IX FRIGATE



K-30 (Luckless)
CLASS IV MONITOR



G-5 (Tugboat)
CLASS VIII CARGO TRANSPORT

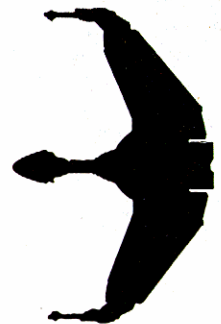

L-42 (Great Bird)
CLASS IX-X FRIGATE



K-14 (Pathmaker)
CLASS IV SCOUT



K-5 (Watcher)
CLASS II-III GUNBOAT

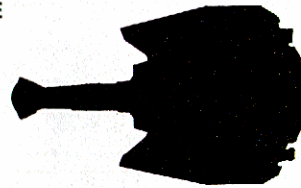

L-13 (Fat Man)
CLASS IX-XI BATTLESHIP



D-10 (Riskadh)
CLASS VIII-X CRUISER



K-3 (Kalath)
CLASS II GUNBOAT

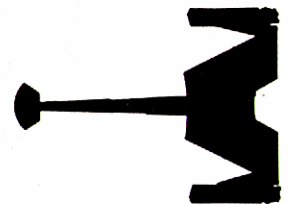

D-18 (Gull)
CLASS VII-IX DESTROYER

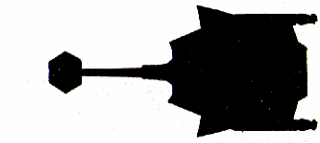

L-9 (Saber)
CLASS X FRIGATE



K-24 (Winner)
CLASS VII ESCORT



S-5 (Healer)
CLASS IV TENDER

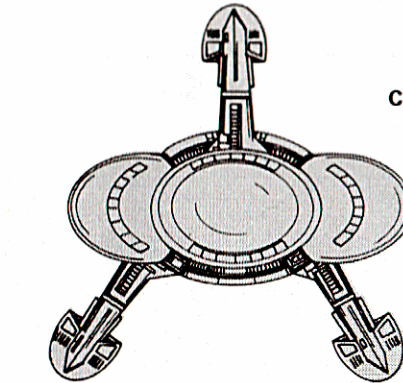

Z-4 (Deathgame)
DEFENSE OUTPOST

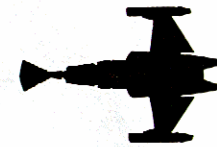

D-20 (Death Rite)
CLASS VII CRUISER



G-6 (Catapult)
CLASS VIII CARGO TRANSPORT



K-17 (Deathstalker)
CLASS III SCOUT



K-6 (Administrator)
CLASS II-IV GUNBOAT

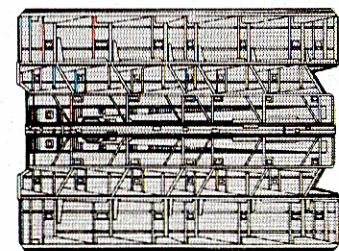

S-8 (Murph)
CLASS VI MOBILE REPAIR FACILITY

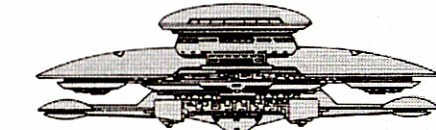

S-4 (Mender)
CLASS VI REPAIR TENDER



K-4 (Enforcer)
CLASS II GUNBOAT



G-8 (Traders Game)
CLASS IV CARGO FREIGHTER

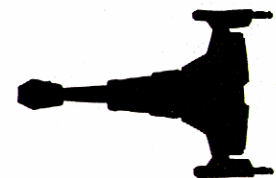

D-2 (Stingtongue)
CLASS VI DESTROYER



D-11 (One Wing)
CLASS VI-VII DESTROYER

Notes:

Known Sphere Of Operation: Empire-wide use
Data Reliability: A for K-23A, K-23B, and K-23D; C for K-23E;
D for K-23F

Major Data Source: Models A, B, and D in Star Fleet possession; Klingon Sector Intelligence

As the Four Years War dragged on and the Klingon lines of supply grew longer, it became apparent to the Klingon Imperial Command that ships designed to perform escort duties were needed. This need had been foreseen when the war was in its planning stages, but the tenacity of Star Fleet was unexpected as the Klingons had never fought a protracted war. The shortage of combat vessels at the front would only permit the Klingons to detail lone destroyers as escorts, but as the raids mounted, the High Command began pulling more and more ships from the front to protect the much-needed supplies. By Stardate 1/97, the advances into Federation territory had stalled, and the K-23 was put into production to end the impasse.

When the K-23, perhaps the most deadly escort vessel in known space, was commissioned into service in 1/9702, its appearance seemed to signify an end to a Klingon tradition in ship design. Earlier designs were a blend of rounded surfaces ending in sharp lines, and the K-23 was a wedge of angular, flat surfaces with no boom or command pod, and no large main hull flying along behind.

The most notable reason for the change in design concept had to do with the war against the Federation. The first and foremost of these was the confusion factor. The Klingons decided to begin a propaganda war against the UFP, and the K-23 was to play a key role. Its angular design would not be readily identifiable as Klingon, and the confusion sowed by this uncertainty could only benefit the Klingon cause. The Klingons started rumors about having an unknown ally, and supported this propaganda by crewing the first K-23s operating in the war zone with Romulan-fusion Klingons. So complete was this ruse that the crewmembers were trained in a battle-language known only to themselves. These hand-picked crews had orders that they were never to be taken prisoners nor was their ship ever to fall into enemy hands, tactics that were to give the class its name (from the Klingon *talat kh'exesta*).

The decision to mount the KWC-1 warp drive system on the earliest K-23s produced was one of economics. Though the original plans for the K-23 called for the more powerful KWD-1 system, not only was the KWC cheaper but it was being produced at the same shipyards as the K-23. This savings in time and money would cost the vessels some of their maneuverability, but, in the Klingon mind, this was a favorable trade-off for being able to produce ships rapidly enough to continue the offensive against the Federation. Even so, the K-23A could cruise at Warp 7, fast enough for the ships to shuttle between convoys travelling at Warp 6 and provide them more protection. The early-model vessels mounted three KD-4 disruptors, each with independent fire control stations, giving them the ability to deliver a more destructive blow than most of the vessels in Star Fleet.

Of the 186 K-23As built, 129 have been converted to Bs, 54 have been destroyed, and 3 have been captured by Star Fleet. Production of the K-23A was halted shortly after the war in response to an Imperial Command order that shipyards would begin producing major components required for the vessels made at their facilities. The result of this order was the K-23B.

The KWD-1 warp drive system mounted on the K-23B delivers more power at the same efficiency rating. Though it is only capable of cruising at Warp 6, the reduction in cruising speed did not effect maneuverability. An improved shield generator also was installed, with the KSI shielding system deliver more protection.

On Stardate 2/1309, the B models were given a general recall, and, by Stardate 2/1601, the refit to the K-23D was complete on all existing vessels. Of the 332 K-23Bs built or converted, 289 have been converted to D models (72 of these were converted A models), 28 have been destroyed, 3 have been captured (2 by the Romulans and 1 by Star Fleet), 6 are listed as missing, 4 have been scrapped, and 2 have been sold to the Orions.

The K-23D was introduced on Stardate 2/1403 with the commissioning of 33 converted B models and 4 newly-built ships. The new model was given a more efficient shield generator, though it actually delivered less protection to any one area. The superstructure was strengthened, and the addition of the KD-13 disruptor increased the offensive range by 120% and the destructive power by 25%. This increase in firepower seems impressive but, in light of existing phaser technology, the K-23D is actually undergunned. With only one of its three disruptors able to fire at 220,000 km and the other two at 100,000 km, the escorts are not able to defend against larger vessels that can stand off at extreme range and deliver multiple blows. This shortcoming has been overcome by increasing the number of vessels escorting a convoy.

Of the 416 K-23Ds built, 322 remain in active service, 24 are in reserve fleets, 4 are used as training vessels, 47 have been destroyed, 5 have been captured (3 by the Romulans and 2 by Star Fleet), 6 are listed as missing, 3 have been scrapped, 2 have been traded to private interests in the Triangle, and 3 have been sold to prominent families within the Empire. Since the introduction of the vessel, the shipyards at Taamar and losia have been producing K-23Ds at an approximate rate of 14 per year.

Soon after the K-23D entered service, the K-23E was introduced with all disruptors upgraded to the KD-13, giving the ships the ability to engage their targets at extended ranges. Even with this increase in offensive range, the K-23s are still found in large groups. The escorts usually operate in flights of three, and one flight will be dispatched with every group of nine transports or freighters. During the Four Years War, the practice had been one escort per nine ships.

Of the 166 K-23Es built, 139 remain in active service, 19 have been destroyed, 3 are listed as missing, 1 has been traded to the Orions, and 4 are in the service of ranking families of the Empire. They are being produced at the facilities of Taamar, losia, and H'renn at an approximate rate of 20 per year.

The K-23F, never directly encountered by Star Fleet, is reported to use the KID-2 impulse drive system and to mount six KD-9 disruptors with fields of fire that include the aft sector. The new weapon arrangement is said to be easily identified by the large, ball-mounted disruptor emplacement on the underside of the bridge and amidships. The K-23F also reportedly has a strengthened superstructure and a more efficient shielding system as well. Ship data experts feel the increased abilities of the K-23 have made it a most dangerous foe.

The K-23F is rarely seen along Federation borders or in the Triangle. Of the about 100 K-23Fs thought to have been built, approximately 80 remain in active service. The disposition of the remaining vessels is unknown at the time of this printing. Intelligence data gathered by Operation Dixie suggests that these vessels are being used along the Klingon coreward borders. The entire complement of vessels constructed at H'renn and losia have been sent to this area, though it appears that only half of those produced at Taamar have been sent coreward. This would account for the limited number sighted by Star Fleet and the Romulans.

K-24 (Winner) CLASS VII ESCORT

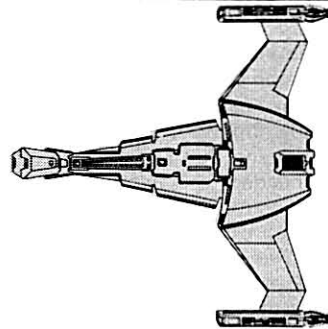

Construction Data:

Model Numbers —	A
Ship Class —	VII
Date Entering Service —	2/1202
Number Constructed —	120

Hull Data:

Superstructure Points —	12
Damage Chart —	C
Size	
Length —	98 m
Width —	100 m
Height —	24 m
Weight —	81,000 mt

Cargo

Cargo Units —	55 SCU
Cargo Capacity —	2,750 mt
Landing Capability —	Yes

Equipment Data:

Control Computer Type —	ZD-6
Transporters —	
standard 6-person	2
emergency 18-person	1
cargo	1

Other Data:

Crew —	160
Passengers —	20
Shuttlecraft —	4

Engines And Power Data:

Total Power Units Available —	38
Movement Point Ratio —	3:1
Warp Engine Type —	KWC-2
Number —	2
Power Units Available —	18
Stress Charts —	L/O
Maximum Safe Cruising Speed —	Warp 8
Emergency Speed —	Warp 9
Impulse Engine Type —	KIB-2
Power Units Available —	2

Weapons And Firing Data:

Beam Weapon Type —	KD-6
Number —	4
Firing Arcs —	1f/p, 1f/s, 1p/a, 1s/a
Firing Chart —	T
Maximum Power —	6
Damage Modifiers —	+2
	(1 - 18)

Shields Data:

Deflector Shield Type —	KSN
Shield Point Ratio —	2:3
Maximum Shield Power —	15

Combat Efficiency:

D.W.F. —	65.2/20.4
----------	-----------



Notes:

Known Sphere Of Operation: Coreward and spinward areas
Data Reliability: D

Major Data Source: Operation Dixie

Although these vessels have never been reported along Federation borders, it is quite possible that they could appear there at anytime. The only contact with one of these vessels has been through Operation Dixie. What is known about their combat capabilities is reflected in the data chart. It should be noted that the *K-24* is very maneuverable and has powerful shields. There is insufficient data to suggest that more than one model is in existence.

Intelligence reports show that these vessels are being produced at the Fonawl facility and, from there, being assigned to the coreward or spinward areas. A second facility may be located at Gerly, but this is unconfirmed.

The class is named from the Klingon *kom ka'des*, which translates to "forever the winner".



K-27 (Grim Reaper) CLASS VI ESCORT

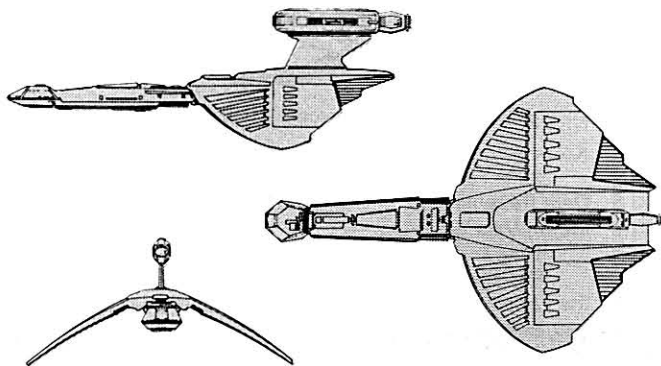

Construction Data:

Model Numbers —	A	C
Ship Class —	VI	VI
Date Entering Service —	2/1604	2/1910
Number Constructed —	100	40

Hull Data:

Superstructure Points —	16	16
Damage Chart —	C	C
Size		
Length —	160 m	160 m
Width —	110 m	110 m
Height —	55 m	55 m
Weight —	61,100 mt	60,650 mt

Cargo

Cargo Units —	60 SCU	60 SCU
Cargo Capacity —	3,000 mt	3,000 mt
Landing Capability —	None	None

Equipment Data:

Control Computer Type —	ZD-5	ZD-5
Transporters —		
standard 6-person	2	2
emergency 18-person	1	1
cargo	1	1
Cloaking Device Type —	None	KCB
Power Requirement —		22

Other Data:

Crew —	155	157
Passengers —	20	20
Shuttlecraft —	3	3

Engines And Power Data:

Total Power Units Available —	36	36
Movement Point Ratio —	3/1	3/1
Warp Engine Type —	KWC-2	KWC-2
Number —	1	1
Power Units Available —	18	18
Stress Charts —	L/N	L/N
Maximum Safe Cruising Speed —	Warp 6	Warp 6
Emergency Speed —	Warp 7	Warp 7
Impulse Engine Type —	KIE-3	KIE-3
Power Units Available —	18	18

Weapons And Firing Data:

Beam Weapon Type —	KD-8	KD-8
Number —	3	2
Firing Arcs —	1p, 1f, 1s	1p, 1s
Firing Chart —	U	U
Maximum Power —	7	7
Damage Modifiers —		
+3	(1 - 7)	(1 - 7)
+2	(8 - 15)	(8 - 15)
+1	(16 - 20)	(16 - 20)
Beam Weapon Type —	KD-12	KD-12
Number —	2	2
Firing Arcs —	A	A
Firing Chart —	H	H
Maximum Power —	9	9
Damage Modifiers —		
+3	(1 - 3)	(1 - 3)
+2	(4 - 8)	(4 - 8)
+1	(9 - 10)	(9 - 10)
Missile Weapon Type —		KP-2
Number —		1
Firing Arcs —		F
Firing Chart —		H
Power To Arm —		1
Damage —		10

Shields Data:

Deflector Shield Type —	KSH	KSH
Shield Point Ratio —	2/3	2/3
Maximum Shield Power —	15	15

Combat Efficiency:

DWDF —	69.4/25.7	69.4/22.9
--------	-----------	-----------



Notes:

Known Sphere Of Operation: Romulan and coreward borders

Data Reliability: E

Major Data Source:

Operation Dixie, Romulan Sector Intelligence

The K-27, encountered by two of the ships from Operation Dixie, has never been reported by any other Star Fleet vessels. Sub-space radio transmissions, intercepted during Operation Dixie, and information gained from Project Grey Ghost have supplied all the information to date.

The bridge section and boom of the K-27 is similar to that of the K-23, and much of this forward design appears to have been borrowed completely from the early models of the more-recognizable escort. As will be noticed in the data, the forward-mounted beam weapons are in the same locations and firing arcs as are those of the early K-23s. The most noticeable feature of the K-27 is the single warp engine. Mounted on a pylon at the rear of the vessel, it is capable of being jettisoned, leaving the ship mostly intact. As of this printing, it is unknown whether the bridge section can be detached.

The introduction of a second model around Stardate 2/19 indicates possible unsatisfactory performance by the original model. The only change reported by Operation Dixie was the exchange of the forward-firing KD-8 disruptor for a KP-2 torpedo. Sub-space communications also indicate that some of these vessels are equipped with the KCB cloaking device. Please note that if the vessel is operating with the cloak activated, it will be considerably harder to detect, due to the single engine.

Reports indicate 110 of these vessels in active service. Reports received from Project Grey Ghost suggest that some of these vessels may be operating on the Romulan border coreward. The manufacturing facility for these ships has not been located; however, the shipyard at Gerly is believed to be producing these vessels.

The name derives from the Klingon *mortum hesta*, which translates to "the maker of the dead".



L-6 (Defender) CLASS VIII - IX FRIGATE

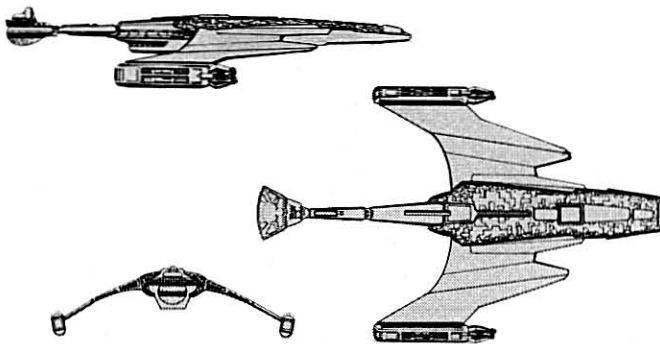

Construction Data:

Model Numbers —	B	G	I
Ship Class —	VIII	VIII	IX
Date Entering Service —	1/9204 - 2/1006	2/0703	2/0911
Number Constructed —	84	110	103

Hull Data:

Superstructure Points —	20	20	20
Damage Chart —	B	B	B
Size			
Length —	200 m	200 m	200 m
Width —	120 m	120 m	120 m
Height —	30 m	30 m	42 m
Weight —	100,700 mt	101,600 mt	123,000 mt
Cargo			
Cargo Units —	140 SCU	140 SCU	140 SCU
Cargo Capacity —	7,000 mt	7,000 mt	7,000 mt
Landing Capability —	None	None	None

Equipment Data:

Control Computer Type —	ZD-5	ZD-5	ZD-5
Transporters —			
standard 6-person	4	4	4
combat 22-person	3	3	3
emergency 18-person	2	2	2
cargo	2	2	2

Other Data:

Crew —	300	310	335
Troops —	300	300	320
Shuttlecraft —	2	2	6

Engines And Power Data:

Total Power Units Available —	38	38	34
Movement Point Ratio —	4.1	4.1	3.1
Warp Engine Type —	KWD-1	KWD-1	KWE-1
Number —	2	2	2
Power Units Available —	18	18	11
Stress Charts —	LN	LN	IL
Maximum Safe Cruising Speed —	Warp 6	Warp 6	Warp 6
Emergency Speed —	Warp 8	Warp 8	Warp 8
Impulse Engine Type —	KIB-2	KIB-2	KIE-2
Power Units Available —	2	2	12

Weapons And Firing Data:

Beam Weapon Type —	KD-6	KD-6	KD-6
Number —	2	4	8
Firing Arcs —	2f	4F	1f/p, 4f, 1f/s, 2a
Firing Chart —	T	T	T
Maximum Power —	6	6	6
Damage Modifiers —			
+ 2	(1 - 18)	(1 - 18)	(1 - 18)
Beam Weapon Type —	KD-4	KD-7	
Number —	4	4	
Firing Arcs —	1f/p, 1f/s, 1f/p, 1f/s	2f, 2a	
Firing Chart —	J	L	
Maximum Power —	4	7	
Damage Modifiers —			
+ 2		(1 - 6)	
+ 1	(1 - 10)	(7 - 12)	

Shields Data:

Deflector Shield Type —	KSE	KSJ	KSG
Shield Point Ratio —	1/1	2/3	1/2
Maximum Shield Power —	9	12	9

Combat Efficiency:

DWDF —	55.1/18.2	66.1/35.6	72.6/40.8
--------	-----------	-----------	-----------



Notes:

Known Sphere Of Operation: Spinward and Coreward borders; Federation border

Data Reliability: C

Major Data Source:

Klingon Sector Intelligence, Operation Dixie

The first encounters with the L-6 frigate came during the Four Years War. Though few of them were met in actual battle, those that did were usually victorious; none was ever captured and only three were destroyed. On Stardate 1/9602, in an engagement that was to typify all subsequent encounters with these vessels in the war, two Larson class destroyers and a Loknar class frigate were bludgeoned by a single L-6. The destroyers *Eylau* and *Jutland* were patrolling the outer fringes of the Falgor system, left behind with the frigate *Proxima* when the main body of the Federation fleet withdrew to reform and ready itself for the inevitable Klingon thrust. The destroyers encountered the L-6 as it entered the area, readied themselves for combat, and dispatched a message to the *Proxima* requesting assistance. The *Jutland* called for the Klingon vessel to surrender as it approached. The L-6 responded by firing on the *Eylau*, damaging its impulse drive system. The *Jutland* closed to extreme range and opened fire, but the damage it inflicted was negligible. While the Klingon ship was concentrating on the incoming *Jutland*, the *Eylau* managed to damage a warp engine, causing the L-6 to turn on the *Eylau* with a withering barrage, destroying the *Eylau's* warp drive controls and causing it to go dead in space. Once again, the *Jutland* fired to minimal effect, and the L-6 renewed its fire on the *Jutland*, which was no match for the Klingon frigate either in terms of firepower or range. The *Jutland* received one damaging blow after another, all from extreme range for its weapons. When the L-6 eventually closed for the kill, it was frustrated by the arrival of the *Proxima*. Approaching the Klingon from the rear, the *Proxima* closed rapidly and delivered a devastating blow to the engineering section, only to be surprised by the Klingon's aft-firing disruptors, which delivered a volley into the bridge and forced it to withdraw. Luckily for the Federation vessels, the moderately-damaged L-6 decided to withdraw, leaving the *Eylau* damaged beyond repair, the *Jutland* severely damaged, and the *Proxima* lightly damaged.

The L-6A went through an interesting change around Stardate 2 09, when the warp engines were changed from the KWD-1 to the KWE-1, and the impulse system was upgraded to the more powerful KIE-2. The warp engines delivered less power than the earlier designs but were more efficient. The impulse system increased its power output over the earlier system by 600%. The overall output of power decreased, however the maneuverability increased. Further changes included the addition of more troops and shuttlecraft as well as improved weaponry and shields. This modification did not alter the basic weakness in the L-6 design, its amidships warp engines.

Of the approximately 300 L-6s built, about 230 remain in active service and about 50 have been destroyed; the disposition of the remainder is unknown. Operation Dixie reports indicate that the L-6 is produced at the Kodal facility.

The class name is translated from the Klingon *t'h'lar*.

L-9 (Saber) CLASS X FRIGATE

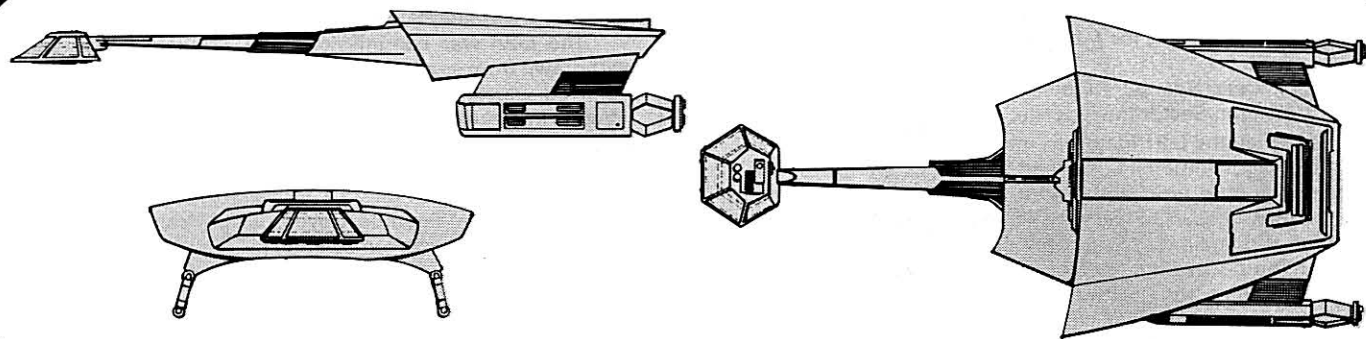

Construction Data:

<i>Model Numbers —</i>	A	B	E	F	G
<i>Ship Class —</i>	X	X	X	X	X
<i>Date Entering Service —</i>	2/1507-2/1510	2/1701	2/2003	2/2102	2/2106
<i>Number Constructed —</i>	32	84	25	25	20

Hull Data:

<i>Superstructure Points —</i>	25	25	27	27	28
<i>Damage Chart —</i>	C	C	C	C	C
<i>Size</i>					
Length —	222 m	222 m	224 m	224 m	230 m
Width —	106 m	106 m	106 m	106 m	106 m
Height —	42 m	42 m	50 m	50 m	50 m
Weight —	146,500 mt	147,350 mt	150,500 mt	151,000 mt	152,100 mt
<i>Cargo</i>					
Cargo Units —	180 SCU	180 SCU	160 SCU	160 SCU	60 SCU
Cargo Capacity —	9,000 mt	9,000 mt	8,000 mt	8,000 mt	3,000 mt
<i>Landing Capability —</i>	None	None	None	None	None

Equipment Data:

<i>Control Computer Type —</i>	ZD-7	ZD-7	ZD-7	ZD-7	ZD-7
<i>Transporters —</i>					
standard 6-person	3	3	3	3	3
combat 22-person	6	6	6	6	4
emergency 18-person	2	2	2	2	2
cargo	2	2	2	2	2

Other Data:

<i>Crew —</i>	420	420	432	435	450
<i>Passengers —</i>	300	300	340	340	240
<i>Shuttlecraft —</i>	6	6	5	5	5

Engines And Power Data:

<i>Total Power Units Available —</i>	42	42	48	52	52
<i>Movement Point Ratio —</i>	4/1	4/1	4/1	4/1	4/1
<i>Warp Engine Type —</i>	KWE-2	KWE-2	KWE-2	KWE-3	KWE-3
<i>Number —</i>	2	2	2	2	2
<i>Power Units Available —</i>	18	18	18	20	20
<i>Stress Charts —</i>	J/M	J/M	J/M	J/M	J/M
<i>Maximum Safe Cruising Speed —</i>	Warp 7	Warp 7	Warp 7	Warp 7	Warp 7
<i>Emergency Speed —</i>	Warp 8	Warp 8	Warp 8	Warp 8	Warp 8
<i>Impulse Engine Type —</i>	KIE-1	KIE-1	KIE-2	KIE-2	KIE-2
<i>Power Units Available —</i>	6	6	12	12	12

Weapons And Firing Data:

<i>Beam Weapon Type —</i>	KD-8	KD-8	KD-8	KD-8	KD-8
<i>Number —</i>	6	6	6	8	8
<i>Firing Arcs —</i>	1f/p, 2f, 1f/s, 2a	1f/p, 2f, 1f/s, 2a	1f/p, 2f, 1f/s, 2a	2f/p, 2f, 2f/s, 2a	2f/p, 2f, 2f/s, 2a
<i>Firing Chart —</i>	U	U	U	U	U
<i>Maximum Power —</i>	7	7	7	7	7
<i>Damage Modifiers —</i>					
+3	(1 - 7)	(1 - 7)	(1 - 7)	(1 - 7)	(1 - 7)
+2	(8 - 15)	(8 - 15)	(8 - 15)	(8 - 15)	(8 - 15)
+1	(16 - 20)	(16 - 20)	(16 - 20)	(16 - 20)	(16 - 20)
<i>Beam Weapon Type —</i>	KD-10	KD-13	KD-13		
<i>Number —</i>	4	4	2		
<i>Firing Arcs —</i>	1p, 2f, 1s	1f/p, 2f, 1f/s	1f/p, 1f/s		
<i>Firing Chart —</i>	C	X	X		
<i>Maximum Power —</i>	3	5	5		
<i>Damage Modifiers —</i>					
+3		(1 - 7)	(1 - 7)		
+2		(8 - 15)	(8 - 15)		
+1	(1 - 6)	(16 - 22)	(16 - 22)		
<i>Missile Weapon Type —</i>					RPL-1
<i>Number —</i>					1
<i>Firing Arcs —</i>					F
<i>Firing Chart —</i>					E
<i>Power To Arm —</i>					10
<i>Damage —</i>					See chart
<i>Missile Weapon Type —</i>			KP-6	KP-6	KP-6
<i>Number —</i>			2	2	1
<i>Firing Arcs —</i>			1f, 1a	1f, 1a	A
<i>Firing Chart —</i>			R	R	R
<i>Power To Arm —</i>			2	2	2
<i>Damage —</i>			20	20	20

Shields Data:

<i>Deflector Shield Type —</i>	KSP	KSP	KSP	KSP	KSP
<i>Shield Point Ratio —</i>	1/3	1/3	1/3	1/3	1/3
<i>Maximum Shield Power —</i>	15	15	15	15	15

Combat Efficiency:

<i>D/WDF —</i>	101.8/39.4	101.8/59.4	110.6/59.8	113.6/60.6	115.0/58.6
----------------	------------	------------	------------	------------	------------



Notes:

Known Sphere Of Operation: Empire-wide use

Data Reliability: A for L-9A; B for L-9B; D for L-9E, L-9F; E for L-9G

Major Data Source: Model A in Star Fleet possession; Klingon Sector Intelligence; Operation Dixie

When the L-9 frigate was introduced on Stardate 2/1507, the Klingon Imperial Command boasted that it was the finest warship ever produced, and it has indeed become one of the most respected warships in known space, proving itself time and again to be a worthy opponent.

The L-9 has the angular design of the earlier K-23 class escorts. Its command pod, like all others, can be jettisoned in emergencies and is capable of life support, limited maneuver, and even weapons fire for up to one year on its own. Engineering, located in the central aft section of the ship, has a secondary bridge used when the main bridge has suffered damage during combat or when the command pod has been separated. Located in the lower decks of the main hull are hypothermia capsules that can be converted into temporary quarters for short missions. The shuttlebay is located forward of the engineering section, the shuttlecraft entering from the underside of the main hull. A total of six, and in earlier models eight, disruptors are mounted in the command pod and on the main hull near the where the boom attaches. A plasma weapon or forward-firing torpedoes are mounted in the lower portion of the main hull, and aft-firing weaponry (including two disruptors) is mounted in the lower rear of the main hull.

Sector Intelligence and Operation Dixie have revealed that L-9s are being produced at the facilities of Taamar, Fonawl, and Gnuu Re'. The latest estimates on production rate are 11 L-9s per year.

The class is named for the *sivista*, a dress sword worn by senior Klingon officers; the exact translation is "fast-sword".

The L-9A, commissioned on Stardate 2/1507, uses the KWE-2 warp drive system, which gives cruising speeds of Warp 7 and in emergency speeds of Warp 8. Mounting four KD-8 and four KF-10 disruptors firing into the forward arc, the L-9A could deliver a devastating blow at close range; the KD-10 has an offensive range of only 60,000 km, however, and this forced the vessel to close with enemies to deliver its full punch, a drawback that made the L-9A an unpopular vessel. The new KSP deflector shield, using a trinary transformer to deliver maximum shield strength at one-third the

power cost, coupled with a reinforced superstructure, made the L-9A a formidable opponent.

The L-9A was commissioned on Stardate 2/1507 and withdrawn from service on Stardate 2/1710, one of the shortest-lived warship models in any navy. Just eight months after its introduction, the L-9A was found to be ineffective in delivering long-range offensive strikes, but, until the facilities were retooled to replace the disruptors with the KD-13, production continued. Of the 32 L-9As built, 18 were converted to L-9Bs, 12 have been destroyed, 1 has been captured by Star Fleet, and 1 has been scrapped.

Although the L-9B is not the newest model, it is the most common. The only change this model incorporates is in the weapons system. The KD-10 disruptors were replaced by the KD-13, increasing the offensive range 350% and allowing the L-9 to deal with opposing capital ships at long range.

Of the 84 L-9Bs built, 66 remain in active service, 14 have been destroyed, 1 has been captured by the Romulans, 2 are listed as missing, and 1 is in the service of a ranking family of the Empire.

In the L-9C, an uprated impulse drive system was added to increase the total power output, but the warp envelope proved unstable, and it was not until the L-9E, mounting the KIE-2, that stability was achieved. The addition of the photon torpedo bays in the fore and aft positions made this model a feared opponent even though two disruptors were dropped from the weapon complement, best approached from the flank even though two of the forward firing disruptors were removed. The E also has a strengthened superstructure.

Of the approximately 25 L-9Es built, reports indicate that two have been destroyed. The disposition of the others is uncertain.

The L-9F mounts the more-powerful KWE-3 warp engines. Furthermore, the KD-13 disruptors have been changed to the KD-8, which does not have the extended range of the KD-13 but delivers a more powerful blow.

Of the approximately 25 L-9Fs built, all are believed to be in active service.

The L-9G is believed to have been responsible for the destruction of the ships of Operation Dixie, but reports confirming the existence of this model are not forthcoming. The model is believed to carry fewer troops than the other models, a reduction thought necessary to house the RPL-1 plasma weapon reportedly mounted in the lower main hull. These vessels are assumed to be operating along the Empire's coreward borders.



L-42 (Great Bird) CLASS IX - X FRIGATE

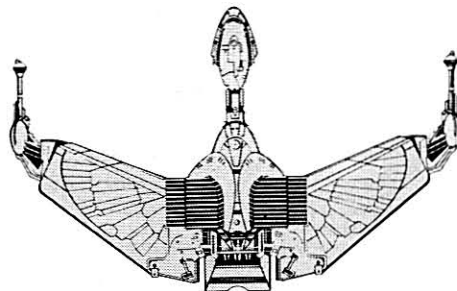
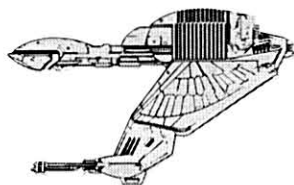

Construction Data:

Model Numbers —	A	B
Ship Class —	IX	X
Date Entering Service —	2:2101	2:2106
Number Constructed —	12	8
Hull Data:		
Superstructure Points —	22	26
Damage Chart —	C	C
Size		
Length —	164 m	164 m
Width —	242 m	242 m
Height —	31 m	31 m
Weight —	120,000 mt	146,400 mt
Cargo		
Cargo Units —	60 SCU	60 SCU
Cargo Capacity —	3,000 mt	3,000 mt
Landing Capability —	None	None
Equipment Data:		
Control Computer Type —	ZD-6	ZD-6
Transporters —		
standard 6-person	3	3
emergency 18-person	2	2
cargo	1	1
Cloaking Device Type —	KCC	KCD
Power Requirement —	32	48
Other Data:		
Crew —	220	240
Passengers —	10	10
Shuttlecraft —	2	2
Engines And Power Data:		
Total Power Units Available —	55	63
Movement Point Ratio —	3:1	4:1
Warp Engine Type —		
Number —	2	2
Power Units Available —	16	20
Stress Charts —	H-J	H-J
Maximum Safe Cruising Speed —	Warp 8	Warp 7
Emergency Speed —	Warp 9	Warp 8
Impulse Engine Type —		
Power Units Available —	KIF-2	KIF-2
Number —	23	23
Weapons And Firing Data:		
Beam Weapon Type —		
Number —	KD-13	KD-13
Firing Arcs —	6 in 2 banks of 3	6 in 2 banks of 3
Firing Chart —	3f p, 3f/s	3f p, 3f/s
Maximum Power —	X	X
Damage Modifiers —	5	5
+3	(1 - 7)	(1 - 7)
+2	(8 - 15)	(8 - 15)
+1	(16 - 22)	(16 - 22)
Missile Weapon Type —		
Number —	KP-6	KP-5
Firing Arcs —	1	4
Firing Chart —	F	2f, 2a
Power To Arm —	R	Q
Damage —	2	1
	20	10
Shields Data:		
Deflector Shield Type —	KSP	KSP
Shield Point Ratio —	1:3	1:3
Maximum Shield Power —	15	15
Combat Efficiency:		
D:WDF —	130.5:40.1	133.2:57.8

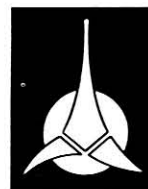

Notes:

Known Sphere Of Operation: Triangle and Romulan borders
Data Reliability: D for D-42A; E for D-42B

Major Data Source:

Operation Dixie; Triangle Sector Intelligence

The L-42 frigate is the largest vessel type produced as a direct result of the last Klingon-Romulan technology exchange. Taking its hull design from the Romulan S-11 class scout, these frigates look very much like a giant K-22 class scout or D-32 class cruiser, sporting the same type of adjustable wings. When cruising, the wings are horizontal and when in combat, they are down; they have no up position for landing, as the vessel is much too large for atmospheric operations. The command pod can be jettisoned in case of emergency, with the entire boom section detaching from the main hull. A departure from standard design is the mounting of disruptors into banks of three, providing devastatingly-concentrated firepower but increasing the danger of major reductions from weapons hits. The efficient engines of the L-42A provide high maneuverability and give extra power to weapons and shields; these vessels are more maneuverable than most capital ships in both the Romulan Navy and Star Fleet.

The L-42B is reported to be more powerful overall but not as maneuverable. It is said to mount two forward- and two aft-firing KP-6 torpedoes. The strength of the superstructure is also said to have been increased.

Of the approximately 20 L-42s believed to have been built, Operation Dixie reported one has been destroyed. The disposition of the remainder is not known. Operation Dixie further reports that the L-42s are currently being produced at the Mustaka shipyards at an approximate rate of six per year. It is highly unlikely that the Klingons will keep the rate at this level, but an increase in the number of facilities is likely and may be underway already. The reports from Operation Dixie indicate that the class is equipped with a cloaking device, but the reliability of such devices on vessels this size is questionable.

The class name is a direct translation of the Klingon *z'gavasta*.

K-3 (Kalath) CLASS II GUNBOAT

Construction Data:		
Model Numbers —	A	B
Ship Class —	II	II
Date Entering Service —	1 8909-2:1106	1 9212
Number Constructed —	466	1,336
Hull Data:		
Superstructure Points —	3	3
Damage Chart —	C	C
Size		
Length —	53 m	53 m
Width —	23 m	23 m
Height —	9 m	9 m
Weight —	8,300 mt	8,500 mt
Cargo		
Cargo Units —	2 SCU	2 SCU
Cargo Capacity —	100 mt	100 mt
Landing Capability —	Yes	Yes
Equipment Data:		
Control Computer Type —	ZD-2	ZD-2
Transporters —	1	1
standard 6-person		
Other Data:		
Crew —	10	10
Engines And Power Data:		
Total Power Units Available —	12	15
Movement Point Ratio —	1/1	1/1
Warp Engine Type —	KWA-2	KWB-2
Number —	1	1
Power Units Available —	10	12
Stress Charts —	P.Q.	O.P.
Maximum Safe Cruising Speed —	Warp 6	Warp 6
Emergency Speed —	Warp 7	Warp 7
Impulse Engine Type —	KIA-2	KIB-1
Power Units Available —	2	3
Weapons And Firing Data:		
Beam Weapon Type —	KD-2	KD-2
Number —	2	2
Firing Arcs —	F	F
Firing Chart —	G	G
Maximum Power —	4	4
Damage Modifiers —	+1	(1 - 10)
Shields Data:		
Deflector Shield Type —	KSB	KSC
Shield Point Ratio —	1.1	1.1
Maximum Shield Power —	10	11
Combat Efficiency:		
DWDF —	35.8/2.8	40.8/2.8

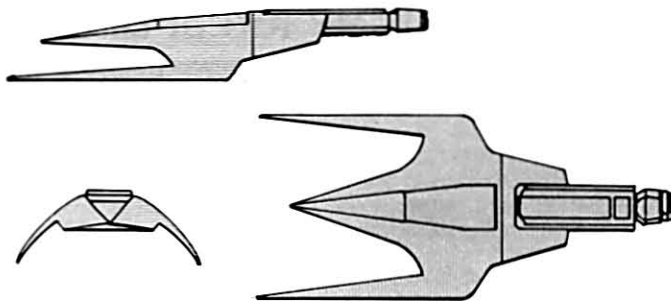

Notes:

Known Sphere Of Operation: Empire Interior
Data Reliability: A

Major Data Source: Vessel in Star Fleet possession

Of the 1802 K-3s built, 997 remain in active service, 222 are in reserve fleets, 18 are used as training vessels, 315 have been destroyed, 31 have been captured (14 by the Romulans, 9 by Star Fleet, 4 by private interests in the Triangle, and 4 by Orions), 27 are listed as missing, 123 were traded to the Romulans, 6 have been traded and 38 sold to private interests in the Triangle, 14 have been sold to Orions, and 11 have been sold to prominent families within the Empire. The K-3, formerly produced at Taamar, Gnuu Re', and Z'hai, is no longer in production.

The class is named for a small, nocturnal predator native to Veridor.

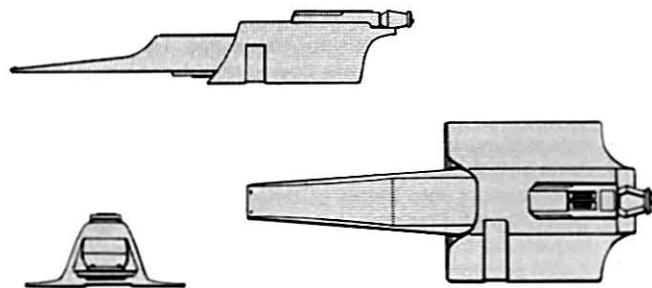

Notes:

Known Sphere Of Operation: Empire-wide use

Data Reliability: A for K-5B; B for K-5C

Major Data Source: K-5B in Star Fleet possession; Klingon Sector Intelligence

Of the 765 K-5s built, 577 remain in active service, 8 are used as training vessels, 106 have been destroyed, 5 Bs have been captured by Star Fleet, 29 are listed as missing, 6 have been scrapped, 12 traded to elements in the Triangle, and 22 are in the service of prominent and ranking families within the Empire. K-5s are being produced at Iosia, Fonawl, and Z'hai at a rate of 40 per year.

The class name is a translation of the Klingon *v's'talo*.



K-5 (Watcher) CLASS II - III GUNBOAT

Construction Data:		
Model Numbers —	B	C
Ship Class —	II	III
Date Entering Service —	2 0711-2:1803	2:1404
Number Constructed —	403	652
Hull Data:		
Superstructure Points —	3	7
Damage Chart —	C	C
Size		
Length —	94 m	96 m
Width —	38 m	38 m
Height —	18 m	20 m
Weight —	12,950 mt	23,300 mt
Cargo		
Cargo Units —	15 SCU	15 SCU
Cargo Capacity —	750 mt	750 mt
Landing Capability —	Yes	Yes
Equipment Data:		
Control Computer Type —	ZD-2	ZD-2
Transporters —	1	1
standard 6-person		
Other Data:		
Crew —	18	18
Passengers —	6	6
Engines And Power Data:		
Total Power Units Available —	14	15
Movement Point Ratio —	1/1	2/1
Warp Engine Type —	KWB-2	KWB-2
Number —	1	1
Power Units Available —	12	12
Stress Charts —	O.P.	O.P.
Maximum Safe Cruising Speed —	Warp 6	Warp 5
Emergency Speed —	Warp 7	Warp 6
Impulse Engine Type —	KIA-2	KIB-1
Power Units Available —	2	3
Weapons And Firing Data:		
Beam Weapon Type —	KD-3	KD-12
Number —	2	2
Firing Arcs —	F	11 a, 11 p
Firing Chart —	I	H
Maximum Power —	5	9
Damage Modifiers —		(1 - 3)
	-3	(4 - 8)
	-2	(9 - 10)
	-1	
Shields Data:		
Deflector Shield Type —	KSE	KSD
Shield Point Ratio —	1.1	1.2
Maximum Shield Power —	12	12
Combat Efficiency:		
DWDF —	41.3/5.4	48.7/4

K-4 (Enforcer) CLASS II GUNBOAT

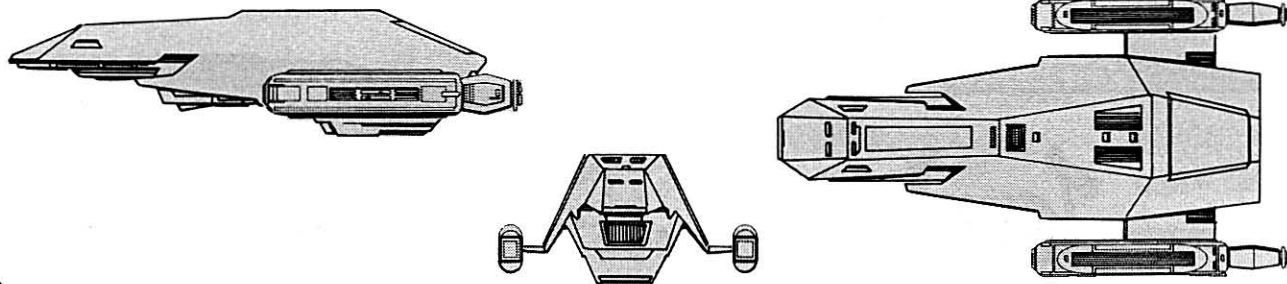

Construction Data:

Model Numbers —	A	B
Ship Class —	II	II
Date Entering Service —	2/1103	2/1308
Number Constructed —	461	480

Hull Data:

Superstructure Points —	3	4
Damage Chart —	C	C
Size		
Length —	56 m	56 m
Width —	28 m	28 m
Height —	14 m	14 m
Weight —	9,688 mt	11,008 mt

Cargo

Cargo Units —	4 SCU	4 SCU
Cargo Capacity —	200 mt	200 mt
Landing Capability —	Yes	Yes

Equipment Data:

Control Computer Type —	ZD-2	ZD-2
Transporters —		
standard 6-person	1	1

Other Data:

Crew —	12	12
Passengers —	6	6

Engines And Power Data:

Total Power Units Available —	12	12
Movement Point Ratio —	1/2	1/2
Warp Engine Type —	KWA-1	KWA-1
Number —	2	2
Power Units Available —	5	5
Stress Charts —	O/P	O/P
Maximum Safe Cruising Speed —	Warp 7	Warp 7
Emergency Speed —	Warp 8	Warp 8
Impulse Engine Type —	KIA-2	KIA-2
Power Units Available —	2	2

Weapons And Firing Data:

Beam Weapon Type —	KD-2	KD-3
Number —	3	2
Firing Arcs —	2 p/f/s, 1 a/p/s	2 p/f/s
Firing Chart —	G	I
Maximum Power —	4	5
Damage Modifiers —		
+1	(1 - 10)	(1 - 12)
Beam Weapon Type —		KD-2
Number —		1
Firing Arcs —		a/p/s
Firing Chart —		G
Maximum Power —		4
Damage Modifiers —		
+1		(1 - 10)

Shields Data:

Deflector Shield Type —	KSE	KSE
Shield Point Ratio —	1/1	1/1
Maximum Shield Power —	12	12

Combat Efficiency:

D.WDF —	55.3/4.2	55.3/6.8
---------	----------	----------

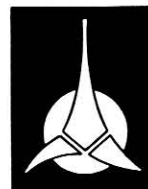

Notes:

Known Sphere Of Operation: Empire-wide use.

Data Reliability: B

Major Data Source: Triangle Sector Intelligence, Klingon Sector Intelligence

The K-4 gunboat/corvette, one of the most maneuverable vessels in known space, is designed to perform two different missions: in-system patrol duties or outpost/border patrol duties when acting as a gunboat, and rapid attack in mass assaults when acting as a corvette. When operating in its gunboat role, the K-4 carries a squad of six marines who are beamed aboard vessels that come under inspection, where they maintain order while the ship is being searched.

The vessel's usefulness as a corvette is exemplified by a search- and-destroy mission led by Admiral zantai Kaneida. On Stardate 2/1811, a small group of Klingon warships, including 25 K-4s, entered the Triangle to destroy or capture any Romulan forces they might encounter. This force enjoyed great success by using variations on a tactical plan, created by the Admiral himself. The plan called for the destroyers to meet and pin the enemy while the cruisers could maneuver into firing positions. When the cruisers began firing, the K-4s would rush in, concentrating their fire on single targets, then zoom away, only to come back again after another target. Whenever a target ship was assaulted by the K-4s, it was under such intense fire from a capital ship that it could not afford to redirect its fire into so many smaller targets. This tactic proved so successful that, although the mission lasted until Stardate 2/2009, only one cruiser, two destroyers, and seven K-4s were lost. Because of this, similar groups have been formed and can be seen operating along Federation borders and within the Triangle.

Of the 941 K-4s built, 331 As and 392 Bs remain in active service, 6 of each type are used as training vessels, 106 As and 63 Bs have been destroyed, 8 As and 3 Bs have been captured by the Romulans, 4 As and 5 Bs have been captured by Star Fleet, and 1 A and 2 Bs have been captured by the Orions, 3 As and 7 Bs are listed as missing, and two each have been sold to ranking families within the Empire. The K-4 is manufactured at losia, Gnuu Re', Fonawl, and H'rez. The estimated rate of production is 50 per year.

The class is named from the translation of the Klingon *kl'xenova*.

K-6 (Administrator) CLASS II - IV GUNBOAT

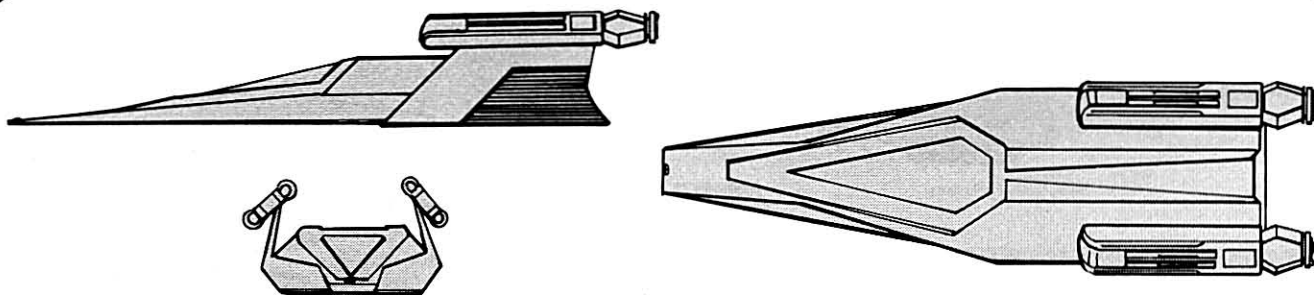

Construction Data:

Model Numbers —	A	C
Ship Class —	II	IV
Date Entering Service —	2/1102-2/1901	2/1306
Number Constructed —	62	367

Hull Data:

Superstructure Points —	3	6
Damage Chart —	C	C
Size		
Length —	54 m	55 m
Width —	23 m	23 m
Height —	10 m	10 m
Weight —	14,600 mt	26,900 mt

Cargo

Cargo Units —	16 SCU	13 SCU
Cargo Capacity —	800 mt	650 mt
Landing Capability —	Yes	Yes

Equipment Data:

Control Computer Type —	ZD-4	ZD-4
Transporters —		
standard 6-person	1	1

Other Data:

Crew —	8	9
Passengers —	4	4

Engines And Power Data:

Total Power Units Available —	22	20
Movement Point Ratio —	2.1	1/1
Warp Engine Type —	KWA-2	KWB-1
Number —	2	2
Power Units Available —	10	9
Stress Charts —	Q.R	O.Q
Maximum Safe Cruising Speed —	Warp 7	Warp 7
Emergency Speed —	Warp 8	Warp 8
Impulse Engine Type —	KIC-1	KIC-1
Power Units Available —	2	2

Weapons And Firing Data:

Beam Weapon Type —	KD-7	KD-7
Number —	1	2 in 1 bank
Firing Arcs —	F	p f s
Firing Chart —	L	L
Maximum Power —	7	7
Damage Modifiers —		
+ 2	(1 - 6)	(1 - 6)
+ 1	(7 - 12)	(7 - 12)

Beam Weapon Type —	KD-4	KD-4
Number —	1	1
Firing Arcs —	A	A
Firing Chart —	J	J
Maximum Power —	4	4
Damage Modifiers —		
+ 1	(1 - 10)	(1 - 10)

Shields Data:

Deflector Shield Type —	KSM	KSJ
Shield Point Ratio —	1/1	2/3
Maximum Shield Power —	15	15

Combat Efficiency:

D.W.D.F. —	41.8:3.8	71.3:9.6
------------	----------	----------



Notes:

Known Sphere Of Operation: Empire-wide use

Data Reliability: A

Major Data Source: K-6A in Star Fleet possession; Orion Sector Intelligence, Klingon Sector Intelligence

K-6 gunboats are found in all areas of Klingon space, especially those occupied by servitor races, where it patrols star systems in groups of five looking for black-marketeers and others involved in illegal acts. It is not intended to deal with capital ships. The K-6 is particularly well-known in the Triangle, where many operate, either under the Klingon banner or some other; recent information indicates that six of the Romulan version, the P-12, operate almost exclusively there.

The K-6A, introduced on Stardate 2/1102 at both Fonawl and Taamar, mounted the KWA-2 warp drive system. This was found to be inadequate for maneuvering the vessel, and the K-6B was designed with improved engines. Before this model was put into production, however, it was replaced with the K-6C, which had improved weapons and shield generators.

The K-6C is more maneuverable, has better than double the firepower, has shields that are 50% more efficient, and has a superstructure capable of taking twice as much damage. Refitting all existing vessels to this configuration was begun immediately, and was completed on Stardate 2/1901.

Of the 1043 K-6s built, 688 remain in active service, 8 are used as training vessels, 92 have been destroyed, 16 have been captured (8 by private interests in the Triangle, 4 by the Romulans, 2 by Orions and 2 by Star Fleet), 11 are listed as missing, 3 have been scrapped, 220 traded to the Romulans (all engines, weapons, and shield systems were removed), and 5 are in the service of a ranking family of the Empire. The K-6 is now being produced at the Taamar, Fonawl, and H'rez facilities at a rate of 60 per year.

The class name is translated from the Klingon *lar'hal*.

K-14 (Pathmaker) CLASS IV SCOUT

Construction Data:			
Model Numbers —	A	C	G
Ship Class —	IV	IV	IV
Date Entering Service —	2,0209 – 1103	2,0902	2,1406
Number Constructed —	105	145	100
Hull Data:			
Superstructure Points —	6	7	8
Damage Chart —	B	B	B
Size			
Length —	145 m	145 m	145 m
Width —	100 m	100 m	100 m
Height —	35 m	35 m	35 m
Weight —	27,050 mt	30,000 mt	32,300 mt
Cargo			
Cargo Units —	10 SCU	10 SCU	12 SCU
Cargo Capacity —	500 mt	500 mt	600 mt
Landing Capability —	Yes	Yes	Yes
Equipment Data:			
Control Computer Type —	ZD-4	ZD-4	ZD-4
Transporters —			
standard 6-person	1	1	1
Other Data:			
Crew —	16	16	17
Shuttlecraft —	1	1	1
Engines And Power Data:			
Total Power Units Available —	20	27	27
Movement Point Ratio —	2/1	2/1	2/1
Warp Engine Type —	KWB-1	KWB-2	KWB-2
Number —	2	2	2
Power Units Available —	9	12	12
Stress Charts —	O Q	P Q	P Q
Maximum Safe Cruising Speed —	Warp 6	Warp 8	Warp 8
Emergency Speed —	Warp 7	Warp 9	Warp 9
Impulse Engine Type —	KIC-1	KIB-1	KIB-1
Power Units Available —	2	3	3
Weapons And Firing Data:			
Beam Weapon Type —	KD-4	KD-7	KD-7
Number —	3	3	3
Firing Arcs —	2f p, s, 1a	2f p, s, 1a	2f p, s, 1a
Firing Chart —	J	L	L
Maximum Power —	4	7	7
Damage Modifiers —			
+2		(1 – 6)	(1 – 6)
+1	(1 – 10)	(7 – 12)	(7 – 12)
Missile Weapon Type —			
Number —			1
Firing Arcs —			F
Firing Chart —			F
Power To Arm —			1
Damage —			6
Shields Data:			
Deflector Shield Type —	KSI	KSM	KSJ
Shield Point Ratio —	1:1	1:1	2:3
Maximum Shield Power —	14	15	14
Combat Efficiency:			
D WDF —	42.6.6	54.3.7.6	63.9.9.1

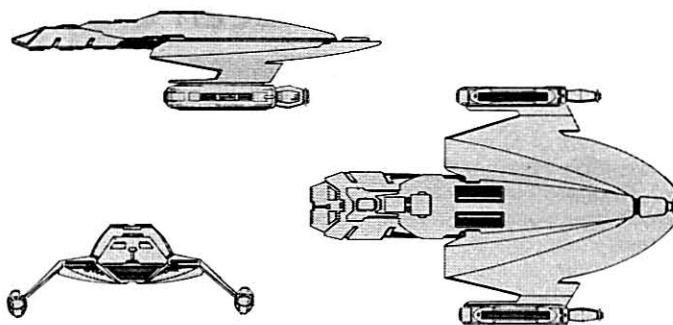

Notes:

Known Sphere Of Operation: Coreward and Spinward areas

Data Reliability: D

Major Data Source: Operation Dixie

Of the approximately 350 K-14s built at Z'hai, intelligence reports indicate that about 225 of them remain in active service, and approximately 100 have been destroyed. The remaining dispositions are uncertain at the time of this printing.

The class name is a rough translation of the Klingon *tas'esta*.

K-17 (Death Stalker) CLASS III SCOUT

Construction Data:			
Model Numbers —	A	D	
Date Entering Service —	1,8808-2,0003	1,9612 – 2/10021	
Number Constructed —	84	44	
Hull Data:			
Superstructure Points —	5	5	
Damage Chart —	C	C	
Size			
Length —	130 m	130 m	
Width —	90 m	90 m	
Height —	20 m	21 m	
Weight —	17,200 mt	23,150 mt	
Cargo			
Cargo Units —	10 SCU	10 SCU	
Cargo Capacity —	500 mt	500 mt	
Landing Capability —	Yes	Yes	
Equipment Data:			
Control Computer Type —	ZD-4	ZD-3	
Transporters —			
standard 6-person	1	1	
Other Data:			
Crew —	14	14	
Engines And Power Data:			
Total Power Units Available —	23	21	
Movement Point Ratio —	3/1	1/1	
Warp Engine Type —	KWA-2	KWB-1	
Number —	2	2	
Power Units Available —	10	9	
Stress Charts —	O R	O Q	
Maximum Safe Cruising Speed —	Warp 6	Warp 7	
Emergency Speed —	Warp 7	Warp 8	
Impulse Engine Type —	KIA-3	KIA-3	
Power Units Available —	3	3	
Weapons And Firing Data:			
Beam Weapon Type —	KD-1	KD-4	
Number —	3	3	
Firing Arcs —	2f, 1a	2f, 1a	
Firing Chart —	B	J	
Maximum Power —	4	4	
Shields Data:			
Deflector Shield Type —	KSB	KSC	
Shield Point Ratio —	1:1	1:1	
Maximum Shield Power —	8	11	
Combat Efficiency:			
D WDF —	29.1.2.1	49.6.6	

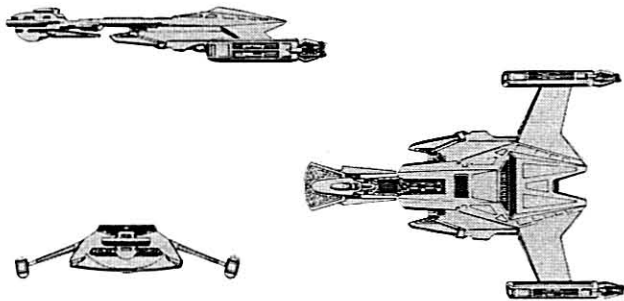

Notes:

Known Sphere Of Operation: Triangle and Spinward areas

Data Reliability: A

Major Data Source: Vessels in Star Fleet possession

Of the 132 K-17s built at Taamar, 46 As and 21 Ds have been destroyed, 5 As and 2 Ds have been captured by Star Fleet, 3 As have been captured by the Romulans, 6 As and 3 Ds are listed as missing, 14 As and 16 Ds have been traded or sold to private interests in the Triangle, and 10 As and 2 Ds are in the service of ranking families in the Empire.

The class name is a translation of the Klingon *z'mortama*.

K-15 (Unseen Creeper) CLASS IV - V SCOUT

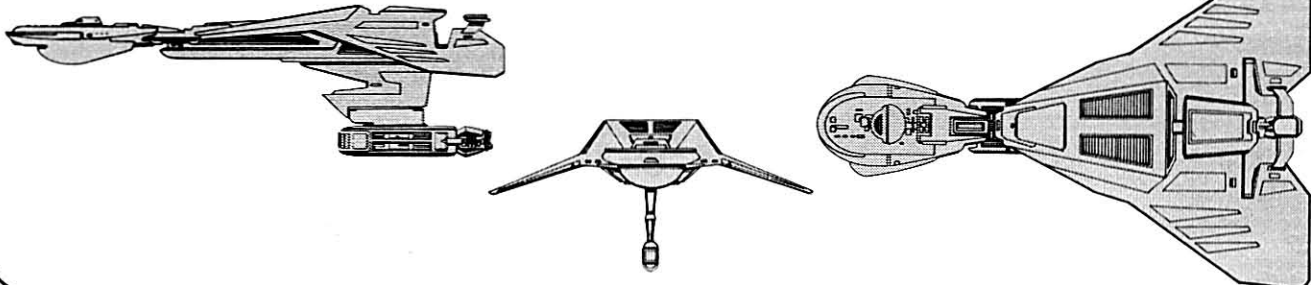

Construction Data:

Model Numbers —	A	D	F
Ship Class —	IV	V	V
Date Entering Service —	2/0307-1202	2/1101	2/1505
Number Constructed —	91	238	120
Hull Data:			
Superstructure Points —	7	8	10
Damage Chart —	C	C	C
Size —			
Length —	100 m	110 m	110 m
Width —	155 m	155 m	155 m
Height —	45 m	50 m	50 m
Weight —	39,100 mt	41,100 mt	46,300 mt
Cargo —			
Cargo Units —	20 SCU	30 SCU	30 SCU
Cargo Capacity —	1,000 mt	1,500 mt	1,500 mt
Landing Capability —	Yes	Yes	Yes
Equipment Data:			
Control Computer Type —	ZD-3	ZD-4	ZD-4
Transporters —			
standard 6-person cargo	1	1	1
cargo	1	1	1
Other Data:			
Crew —	120	124	126
Passengers —	2	2	2
Engines And Power Data:			
Total Power Units Available —	16	20	25
Movement Point Ratio —	2/1	2/1	2/1
Warp Engine Type —	KWC-1	KWC-2	KWC-3
Number —	1	1	1
Power Units Available —	14	18	22
Stress Charts —	K/N	L/N	L/M
Maximum Safe Cruising Speed —	Warp 7	Warp 7	Warp 7
Emergency Speed —	Warp 8	Warp 8	Warp 8
Impulse Engine Type —	KIC-1	KIC-1	KIB-1
Power Units Available —	2	2	3
Weapons And Firing Data:			
Beam Weapon Type —	KD-3	KD-3	KD-7
Number —	4	4	4
Firing Arcs —	2f, 1a p, 1a s	2f, 1a p, 1a s	2f, 1a p, 1a s
Firing Chart —	I	I	L
Maximum Power —	5	5	7
Damage Modifiers —			
+2			(1 - 6)
+1	(1 - 12)	(1 - 12)	(7 - 12)
Missile Weapon Type —			KP-2
Number —			1
Firing Arcs —			F
Firing Chart —			H
Power To Arm —			1
Damage —			10
Shields Data:			
Deflector Shield Type —	KSI	KSJ	KSJ
Shield Point Ratio —	1/1	2/3	2/3
Maximum Shield Power —	14	14	14
Combat Efficiency:			
D/WDF —	41.5/10.8	53.4/10.8	60.8/18.5



Notes:

Known Sphere Of Operation: Empire-wide use, frequently operates in Spinward frontiers and the Triangle

Data Reliability: A for K-15A; C for K-15D, K-15E

Major Data Source: K-15A in Star Fleet possession; Klingon Sector Intelligence, Triangle Sector Intelligence

The K-15 is the most likely Klingon scout vessel to be encountered anywhere in known space. Only the K-15D and K-15F models are in service at present, but newer models could appear at any time, as the design is well accepted by both officers and crew.

Of the 391 K-15s built, 196 Ds and 92 Fs remain in active service, 1 each are used as training vessels, 21 As, 19 Ds, and 14 Fs have been destroyed, 2 A each have been captured by Star Fleet and the Romulans, 3 As, 14 Ds, and 9 Fs are listed as missing, 5 As and 2 Ds were traded to the Romulans, 2 Ds have been sold to private interests in the Triangle, 1 D has been sold to the Orions, and 3 Ds and 4 Fs have been sold to prominent families with the Empire. The K-15 is being produced at the Taamar and Gnuu Re' facilities. Combined annual production is 15 of each type.

The class name is a reference to the Klingon *l'rexa*, which translates to "slowly and unseen".



K-22 (Bird Of Prey) CLASS V SCOUT

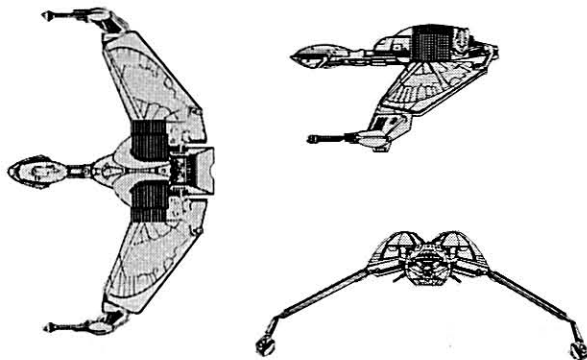

Construction Data:

Model Numbers —	A	B
Date Entering Service —	2/1805	2/1906
Number Constructed —	8	72

Hull Data:

Superstructure Points —	10	10
Damage Chart —	C	C
Size		
Length —	88 m	88 m
Width —	130 m	130 m
Height —	16 m	16 m
Weight —	46,300 mt	47,000 mt

Cargo

Cargo Units —	5 SCU	5 SCU
Cargo Capacity —	250 mt	250 mt
Landing Capability —	Yes	Yes

Equipment Data:

Control Computer Type —	ZD-4	ZD-4
Transporters —		
standard 6-person	1	1
Cloaking Device Type —	KCB	KCB
Power Requirement —	22	22

Other Data:

Crew —	12	14
--------	----	----

Engines And Power Data:

Total Power Units Available —	25	25
Movement Point Ratio —	2/1	2/1
Warp Engine Type —	KWC-3	KWC-3
Number —	1	1
Power Units Available —	22	22
Stress Charts —	L/M	L/M
Maximum Safe Cruising Speed —	Warp 7	Warp 7
Emergency Speed —	Warp 8	Warp 8
Impulse Engine Type —	KIB-1	KIB-1
Power Units Available —	3	3

Weapons And Firing Data:

Beam Weapon Type —	KD-8	KD-8
Number —	2	2
Firing Arcs —	1f p, 1f s	1f p, 1f s
Firing Chart —	U	U
Maximum Power —	7	7
Damage Modifiers —		
+3	(1 - 7)	(1 - 7)
+2	(8 - 15)	(8 - 15)
+1	(16 - 20)	(16 - 20)

Beam Weapon Type —

Number —	1	1
Firing Arcs —	A	A
Firing Chart —	H	H
Maximum Power —	9	9
Damage Modifiers —		
+3	(1 - 3)	(1 - 3)
+2	(4 - 8)	(4 - 8)
+1	(9 - 10)	(9 - 10)

Missile Weapon Type —

Number —	KP-5	KP-5
Number —	1	1
Firing Arcs —	1f	F
Firing Chart —	Q	Q
Power To Arm —	1	1
Damage —	10	10

Shields Data:

Deflector Shield Type —	KSC	KSD
Shield Point Ratio —	1/1	1/2
Maximum Shield Power —	10	11

Combat Efficiency:

D/WDF —	45.8/17.7	65.3/21.4
---------	-----------	-----------

Notes:

Known Sphere Of Operation: Empire-wide use

Data Reliability: D for K-22A; A for K-22B

Major Data Source: K-22B in Star Fleet possession, Klingon Sector Intelligence



The infamous K-22 (*Bird Of Prey*) scout is the Klingon prong of the double threat posed to Star Fleet by vessels of this design, equipped with cloaking devices and operated by both the Klingon and Romulan navies. The wing mechanisms of these vessels are ingenious and practical, the most interesting feature of the design. When the vessel is cruising, the wings are extended horizontally, which distributes the stress evenly throughout the vessel. When in combat, the wings are down, which gives a broader field of fire and protects a weak area on the lower central hull. When performing atmospheric operations, the wings are up, which gives more lift when the "feather" plates located along the wings, (originally thought to be merely decorative), are individually adjusted to compensate for air turbulence.

The command pod of the K-22 is a blending of Klingon and Romulan designs, but it cannot be detached in an emergency, for the heart of the ship is located in the main hull, including the computer system and the life-support system. Also located within the aft hull of the ship are the warp engines, which cannot be jettisoned, as well as the transporter system and the exit ramp. The cloaking device that is used on this vessel is unreliable at best; it has been confirmed the device is capable of driving crewmembers mad, though Federation medical specialists do not fully understand the cause.

The most important fact concerning the construction of these vessels was that the Klingons already were producing approximately 80% of the internal components prior to receiving prototypes from the Romulans. On Stardate 2/1805, the Romulans delivered seven hulls and an undetermined number of cloaking devices, and, within 13 months, the Imperial Navy commissioned its first vessels.

The S-11 hulls were fitted out into the K-22A. As received from the Romulans, they had no mounting point for an aft-firing disruptor. Intelligence reports indicate that all seven of these vessels were completed, but that afterward no production-model vessels were constructed. The disposition of these seven ships is unknown.

The first production model, the K-22B, was modified to accept the KD-12. A further modification was made to allow the KSD shielding system to be installed. These systems increase offensive capabilities by 25% and defensive capabilities by 45%. These vessels are very maneuverable in combat and have an impressive offensive capability. Although they are not really capable of fighting major warships, they are able to defend themselves long enough to engage their warp systems to escape, with the ability to travel at Warp 8 in emergencies.

The K-22B may be found in all areas of space, performing its missions of espionage and terrorism; they have been reported by Klingon, Triangle, Romulan, and Spinward Sector Intelligence as operating in those respective areas. The ability of the ship to penetrate outer defenses and travel freely about the Federation was seen recently, when one of them was captured by Adm. James T. Kirk. In an attempt to steal the plans of the secret Genesis Project, a K-22B penetrated Federation space undetected as far as the Mutara Nebula. Most of the information about this class, and the similar Romulan S-11 scout, was obtained from the computer banks of the captured vessel.

Of the 79 K-22Bs built, 1 has been captured by Star Fleet and the remaining 78 are believed to be in active service, their whereabouts unknown. The K-22 is being produced at the Taamar facility at an approximate rate of 20 per year.

The class name is a reference to the Romulan name for the S-11; the Klingon name *D'Gavama* is a direct translation of "bird of prey".

K-30 (Luckless) CLASS IV MONITOR

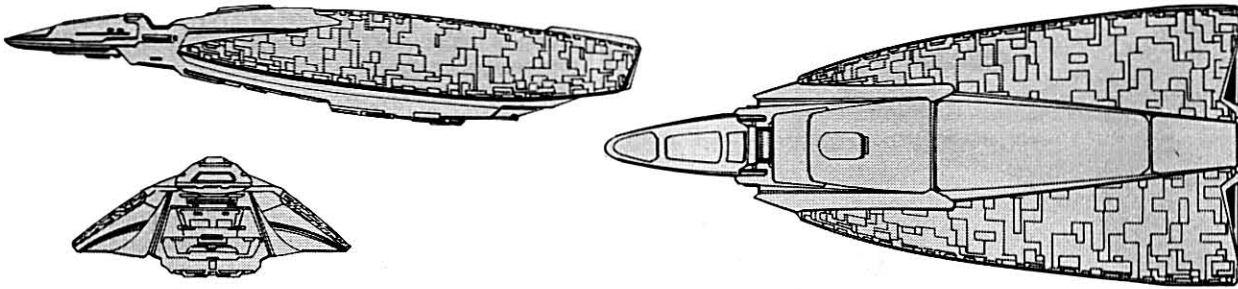

Construction Data:

Model Numbers —	A	E
Ship Class —	IV	IV
Date Entering Service —	1/9001 – 2/0202	1/9804 – 2/0901
Number Constructed —	172	72

Hull Data:

Superstructure Points —	8	10
Damage Chart —	C	C
Size		
Length —	106 m	106 m
Width —	46 m	46 m
Height —	20 m	20 m
Weight —	27,900 mt	25,200 mt

Cargo

Cargo Units —	20 SCU	20 SCU
Cargo Capacity —	1,000 mt	1,000 mt
Landing Capability —	Yes	Yes

Equipment Data:

Control Computer Type —	ZD-3	ZD-4
Transporters —		
standard 6-person	1	1

Other Data:

Crew —	30	30
Passengers —	10	10
Shuttlecraft —	1	1

Engines And Power Data:

Total Power Units Available —	20	26
Movement Point Ratio —	2/1	2/1
Warp Engine Type —	KSLA	KSLB
Number —	2	2
Power Units Available —	9	12
Stress Charts —	J/M	K/N
Impulse Engine Type —	KIC-1	KIC-1
Power Units Available —	2	2

Weapons And Firing Data:

Beam Weapon Type —	KD-2	KD-3
Number —	7	6
Firing Arcs —	2f p, 2f, 2f s, 1a	2f p, 2f, 2f s
Firing Chart —	G	I
Maximum Power —	4	5
Damage Modifiers —		
+1	(1 – 10)	(1 – 12)
Beam Weapon Type —		KD-2
Number —		1
Firing Arcs —		A
Firing Chart —		G
Maximum Power —		4
Damage Modifiers —		
+1		(1 – 10)

Shields Data:

Deflector Shield Type —	KSC	KSJ
Shield Point Ratio —	1/1	2/3
Maximum Shield Power —	11	14

Combat Efficiency:

D/WDF —	41.49.8	61.5/17.6
---------	---------	-----------



Notes:

Known Sphere Of Operation: Orion space and the Triangle
Data Reliability: A

Major Data Source: K-30A and K-30E in Star Fleet possession

The K-30 was introduced into service to replace the obsolete K-12 monitor, which was unable to operate alone, due to the lack of sufficient maneuvering capability and weaponry. The Empire was expanding at a very rapid pace and needed modern, cost-efficient ships that could operate alone. On Stardate 1/9001, the first of the K-30s were commissioned into service from the Taamar shipyards.

Not long after the commissioning ceremonies, an incident occurred that was an omen for the K-30's future. A special carrier had been built to move the K-30s to their duty stations. While the first five monitors were being loaded onto one of these carriers, a collision occurred between two of them. Within one year, five of the 20 K-30s produced at Taamar had been destroyed, only one by hostile action. The class was building a reputation for being accident-prone. To add to the reputation, the K-30B and K-30C repeated failed tests of their new sub-light engines and were never put into production. The K-30D prototype, with the new sub-light engine and a new shield generator, suffered several mishaps, one of which damaged the ship so badly that a replacement had to be built. During the final stages of construction, the engine contractor had come up with an improved version of the original design and supplied it instead. The new prototype with the replacement engine, now the K-30E, was successfully tested, but, on Stardate 1/9804, the first five production models were destroyed in a mysterious explosion during loading operations. A prevalent Klingon nickname for the class refers to this series of events; oftimes called *K'nel* ("spell"), the ships of this class are not liked by most Klingon captains and crews.

The production of the K-30 was halted on Stardate 2/0110 in favor of a newer design. As the K-30s were replaced, they were sold or traded. Of the 244 K-30s built at Taamar, 132 were destroyed, 11 have been captured by Star Fleet, 6 are listed as missing, 51 have been scrapped, 9 have been traded to the Orions and 8 to private interests in the Triangle, and 22 have been sold to private interests in the Triangle and 5 to the Orions.

K-32 (Strong Victor) CLASS IV MONITOR

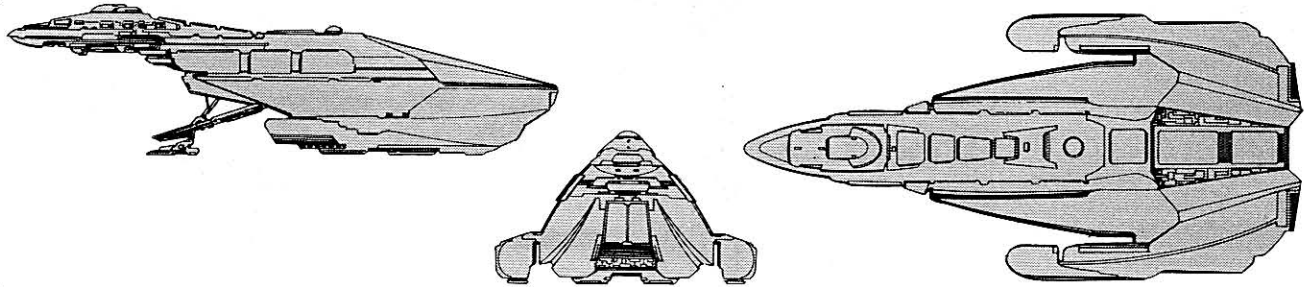

Construction Data:

<i>Model Numbers—</i>	A	B
<i>Ship Class—</i>	IV	IV
<i>Date Entering Service—</i>	2/0105	2/0710
<i>Number Constructed—</i>	331	240
Hull Data:		
<i>Superstructure Points—</i>	10	10
<i>Damage Chart—</i>	C	C
<i>Size</i>		
Length—	110 m	110 m
Width—	52 m	52 m
Height—	30 m	30 m
Weight—	35,700 mt	36,700 mt
<i>Cargo</i>		
Cargo Units—	42 SCU	42 SCU
Cargo Capacity—	2,100 mt	2,100 mt
Landing Capability—	Yes	Yes
Equipment Data:		
<i>Control Computer Type—</i>	ZD-4	ZD-4
<i>Transporters—</i>		
standard 6-person	1	1
Other Data:		
Crew—	32	34
Passengers—	10	10
Shuttlecraft—	1	1
Engines And Power Data:		
<i>Total Power Units Available—</i>	27	27
<i>Movement Point Ratio—</i>	2/1	2/1
<i>Warp Engine Type—</i>	KSLB	KSLB
Number—	2	2
Power Units Available—	12	12
Stress Charts—	K/N	K/N
<i>Impulse Engine Type—</i>	KIB-2	KIB-2
Power Units Available—	3	3
Weapons And Firing Data:		
<i>Beam Weapon Type—</i>	KD-7	KD-7
Number—	4	4
Firing Arcs—	2f/p, 2f/s	2f/p, 2f/s
Firing Chart—	L	L
Maximum Power—	7	7
Damage Modifiers—		
+2	(1 - 6)	(1 - 6)
+1	(7 - 12)	(7 - 12)
<i>Beam Weapon Type—</i>	KD-2	KD-4
Number—	4	4
Firing Arcs—	2p/a, 2s/a	2p/a, 2s/a
Firing Chart—	G	J
Maximum Power—	4	4
Damage Modifiers—		
+1	(1 - 10)	(1 - 10)
Shields Data:		
<i>Deflector Shield Type—</i>	KSJ	KSD
Shield Point Ratio—	2/3	1/2
Maximum Shield Power—	14	11
Combat Efficiency:		
<i>D/WDF—</i>	62.3/20.8	67.3/23.2



Notes:

Known Sphere Of Operation: Empire-wide use

Data Reliability: B

Major Data Source: Klingon Sector Intelligence

After the Four Years War, the Klingons began to feel the need for more monitors not only to replace the many that had been destroyed, but also to patrol their substantial gain of territory. The K-32 was introduced to solve two problems: to increase the Klingon presence around their servitor territories and to replace the highly unpopular K-30. Ships of this class carry a squad of ten marines for security reasons and possible boarding actions.

After many failures, the KSLB was perfected and installed on the K-32A, allowing it to maneuver well while devoting sufficient power to the offensive systems. The weapons arrangement is highly effective, giving the ability to discharge six disruptors in either the forward or aft arcs.

Of the 571 K-32s built, 279 As and 199 Bs remain in active service, 2 each are used as training vessels, 33 As and 21 Bs have been destroyed, 2 As and 1 B have been captured by private interests in the Triangle, 2 As and 3 Bs are listed as missing, 7 As and 10 Bs have been sold or traded to private interests in the Triangle, and 6 As and 4 Bs are in the service of prominent and ranking families of the Empire. The K-32s are produced at Taamar and H'rez. The combined rate of production is 15 of each type per year.

The class name is a translation of the Klingon *v'al'kon*.



G-3 (Baka Re') CLASS VII-VIII CARGO FREIGHTER

Construction Data:

Model Numbers—	A	B
Ship Class—	VII	VIII
Date Entering Service—	2/0406	2/1510
Number Constructed—	292	181

Hull Data:

Superstructure Points—	9	10
Damage Chart—	B	B
Size		
Length—	240 m	240 m
Width—	140 m	140 m
Height—	60 m	60 m
Weight—	81,500 mt	113,100 mt

Cargo

Cargo Units—	3,600 SCU	3,800 SCU
Cargo Capacity—	180,000 mt	190,000 mt
Landing Capability—	None	None

Equipment Data:

Control Computer Type—	ZD-5	ZD-5
------------------------	------	------

Transporters—

standard 6-person	1	1
cargo small	10	10
large	6	6

Other Data:

Crew—	30	32
Passengers—	10	10
Shuttlecraft—	6	6

Engines And Power Data:

Total Power Units Available—	40	40
Movement Point Ratio—	4/1	4/1
Loaded	6/1	7/1
Warp Engine Type—	KWD-1	KWE-2
Number—	2	2
Power Units Available—	18	18
Stress Charts—	L/N	J/M
Maximum Safe Cruising Speed—	Warp 6	Warp 7
Loaded	Warp 4	Warp 5
Emergency Speed—	Warp 8	Warp 8
Loaded	Warp 5	Warp 6
Impulse Engine Type—	KIC-2	KIC-2
Power Units Available—	4	4

Shields Data:

Deflector Shield Type—	KSJ	KSN
Shield Point Ratio—	2/3	2/3
Maximum Shield Power—	13	14

Combat Efficiency:

D/WDF—	53.4/0	56.3/0
--------	--------	--------

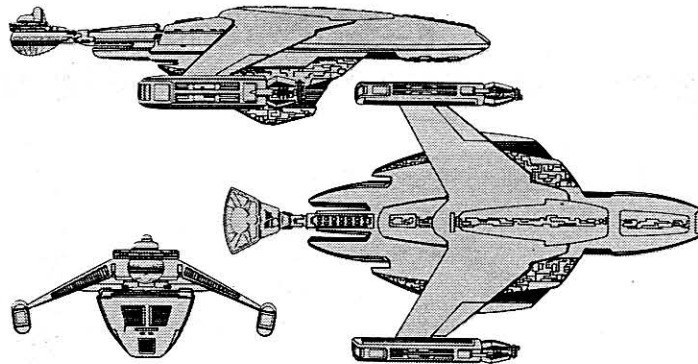

Notes:

Known Sphere Of Operation: Empire-wide use; the Triangle and Orion space

Data Reliability: C

Major Data Source: Triangle Sector Intelligence, Orion Sector Intelligence

Of the 473 G-3 freighters built, 256 As and 167 Bs remain in active service, 28 As and 9 Bs have been destroyed, 3 As and 1 B are listed as missing, 1 of each has been scrapped, 2 As and 2 Bs have been traded to the Romulans, and 2 As and 1 B have been sold to the Orions. The G-3s are produced at Gnuu Re' and Mustaka, with a combined annual rate of 24.

The class name is the Klingon word for "pregnant".

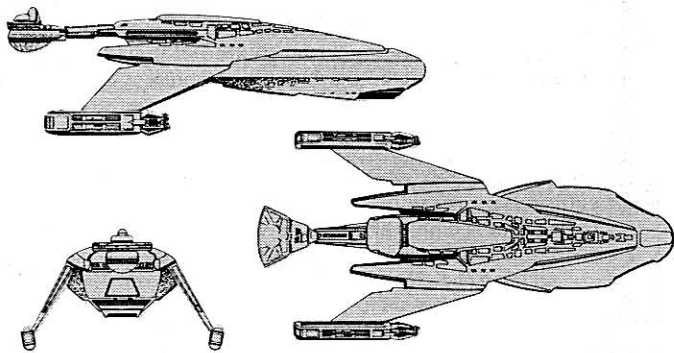

Notes:

Known Sphere Of Operation:

Empire-wide use; the Triangle and Orion space

Data Reliability: B

Major Data Source:

Orion Sector Intelligence, Triangle Sector Intelligence

Of the 531 G-8s built, 308 remain in active service, 191 have been destroyed, 17 have been captured (6 by Star Fleet, 6 by Orions, and 5 by the Romulans), 8 are listed as missing, 5 have been scrapped, and 2 have been sold to private interests in the Triangle. The G-8s are being produced at Taamar, Fonawl, and Z'hai with a combined rate of 18 per year.

The class name is from the Klingon *plen zha*, translates to "trader's game".



G-8 (Traders Game) CLASS IV CARGO FREIGHTER

Construction Data:

Model Numbers—	A
Ship Class—	N
Date Entering Service—	1/9501
Number Constructed—	531

Hull Data:

Superstructure Points—	7
Damage Chart—	A
Size	
Length—	210 m
Width—	100 m
Height—	60 m
Weight—	35,200 mt

Cargo

Cargo Units—	2,300 SCU
Cargo Capacity—	115,000 mt
Landing Capability—	None

Equipment Data:

Control Computer Type—	ZD-4
------------------------	------

Transporters—

standard 6-person	1
cargo	8

Other Data:

Crew—	24
Passengers—	6
Shuttlecraft—	4

Engines And Power Data:

Total Power Units Available—	29
Movement Point Ratio—	2/1
Loaded	6/1
Warp Engine Type—	KWB-3
Number—	2
Power Units Available—	13
Stress Charts—	Q/Q
Maximum Safe Cruising Speed—	Warp 8
Loaded	Warp 4
Emergency Speed—	Warp 9
Loaded	Warp 5
Impulse Engine Type—	KIB-1
Power Units Available—	3

Weapons And Firing Data:

Beam Weapon Type—	KD-1
Number—	2
Firing Arcs—	1 p.f.s. 1p.a.s
Firing Chart—	B
Maximum Power—	4

Shields Data:

Deflector Shield Type—	KSE
Shield Point Ratio—	1/1
Maximum Shield Power—	11

Combat Efficiency:

D/WDF—	46/1.4
--------	--------

G-5 (Tugboat) CLASS VIII CARGO TRANSPORT

Construction Data:	
Model Numbers —	A
Date Entering Service —	2/1012
Number Constructed —	386
Hull Data:	
Superstructure Points —	12
Damage Chart —	A
Size	
Length —	110 m
Width —	80 m
Height —	40 m
Weight —	102,900 mt
Cargo	
Cargo Capacity —	250,000 mt
Landing Capability —	None
Equipment Data:	
Control Computer Type —	ZD-4
Transporters —	
standard 6-person	1
Other Data:	
Crew —	20
Passengers —	2
Shuttlecraft —	2
Engines And Power Data:	
Total Power Units Available —	26
Movement Point Ratio —	3/1
Loaded	7/1
Warp Engine Type —	KWE-1
Number —	2
Power Units Available —	11
Stress Charts —	I/L
Maximum Safe Cruising Speed —	Warp 6
Loaded	Warp 4
Emergency Speed —	Warp 8
Loaded	Warp 5
Impulse Engine Type —	KID-2
Power Units Available —	4
Shields Data:	
Deflector Shield Type —	KSG
Shield Point Ratio —	1/2
Maximum Shield Power —	9
Combat Efficiency:	
D/WDF —	54.2/0

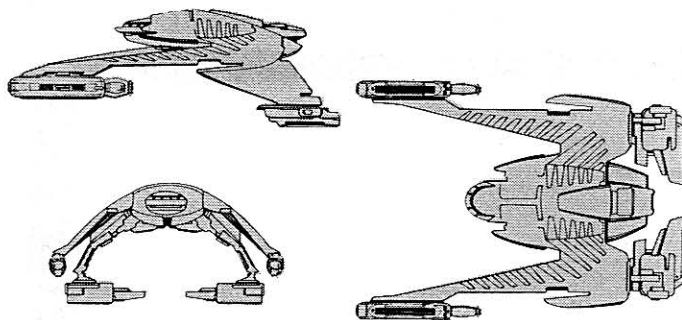

Notes:

Known Sphere Of Operation: Empire-wide use; the Triangle
Data Reliability: B

Major Data Source: Klingon Sector Intelligence, Triangle Sector Intelligence

Of the 386 G-5s built, 338 remain in active service, 21 have been destroyed, 2 have been captured by private interests in the Triangle, 13 are listed as missing, 3 have been scrapped, and 12 have been traded to the Romulans. The G-5 is manufactured at the facilities of Gnuu Re' and Taamar. Annual production rate is 30.

The name, an obvious reference to its function, is a translation of the Klingon *qexa*.

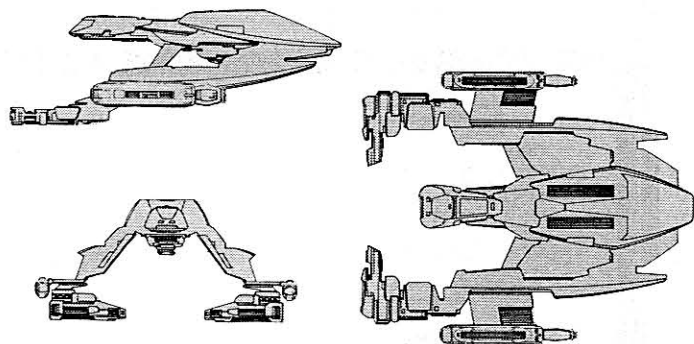

G-6 (Catapult) CLASS VIII CARGO TRANSPORT

Construction Data:	
Model Numbers —	A
Date Entering Service —	2/1407
Number Constructed —	252
Hull Data:	
Superstructure Points —	10
Damage Chart —	B
Size	
Length —	120 m
Width —	90 m
Height —	40 m
Weight —	115,800 mt
Cargo	
Cargo Capacity —	280,000 mt
Landing Capability —	None
Equipment Data:	
Control Computer Type —	ZD-6
Transporters —	
standard 6-person	1
cargo	1
Other Data:	
Crew —	22
Passengers —	3
Shuttlecraft —	2
Engines And Power Data:	
Total Power Units Available —	44
Movement Point Ratio —	3/1
Loaded	6/1
Warp Engine Type —	KWE-3
Number —	2
Power Units Available —	20
Stress Charts —	J/M
Maximum Safe Cruising Speed —	Warp 8
Loaded	Warp 5
Emergency Speed —	Warp 9
Loaded	Warp 6
Impulse Engine Type —	KID-2
Power Units Available —	4
Shields Data:	
Deflector Shield Type —	KSG
Shield Point Ratio —	1/2
Maximum Shield Power —	9
Combat Efficiency:	
D/WDF —	69.3.6

Notes:

Known Sphere Of Operation: Empire-wide use; the Triangle
Data Reliability: C

Major Data Source: Klingon Sector Intelligence, Triangle Sector Intelligence

Of the 252 G-6s built, 216 remain in active service, 17 have been destroyed, 7 are listed as missing, 2 have been destroyed, and 10 have been traded to the Romulans.

The G-6 is being produced at Iosia and Gnuu Re' at a combined rate of 28 per year.

The class name is from the Klingon *besz ra'te'*, which translates as "throwing machine".



W-2 (Koreba) CLASS II - III WARPSHUTTLE

Construction Data:

Model Numbers—	A	C	F
Ship Class—	II	III	II
Date Entering Service—	1,9009	2,1102	2,1812
Number Constructed—	863	50	280

Hull Data:

Superstructure Points—	4	8	4
Damage Chart—	C	C	C
Size			
Length—	84 m	84 m	84 m
Width—	24 m	24 m	24 m
Height—	17 m	18 m	18 m
Weight—	14,300 mt	23,700 mt	14,500 mt

Cargo			
Cargo Units—	28 SCU	28 SCU	28 SCU
Cargo Capacity—	1,400 mt	1,400 mt	1,400 mt
Landing Capability—	Yes	Yes	Yes

Equipment Data:

Control Computer Type—	ZD-2	ZD-4	ZD-2
Transporters—			
standard 6-person	1	1	1

Other Data:

Crew—	13	13	13
Passengers—	10	10	10

Engines And Power Data:

Total Power Units Available—	14	14	15
Movement Point Ratio—	1/1	2/1	1/1
Warp Engine Type—	KWB-2	KWB-2	KWB-2
Number—	1	1	1
Power Units Available—	12	12	12
Stress Charts—	O.P	O.P	O.P
Maximum Safe Cruising Speed—	Warp 6	Warp 5	Warp 6
Emergency Speed—	Warp 7	Warp 6	Warp 7
Impulse Engine Type—	KIA-2	KIA-2	KIA-3
Power Units Available—	2	2	3

Weapons And Firing Data:

Beam Weapon Type—	KD-1	KD-2	KD-3
Number—	2	2	2
Firing Arcs—	2F	2F	2F
Firing Chart—	B	G	I
Maximum Power—	4	4	5
Damage Modifiers—			
+ 1		(1 - 10)	(1 - 12)

Shields Data:

Deflector Shield Type—	KSC	KSD	KSE
Shield Point Ratio—	1/1	1/2	1/1
Maximum Shield Power—	11	13	12

Combat Efficiency:

D.WDF—	41.2/1.4	52.4/2.8	55.2/5.4
--------	----------	----------	----------

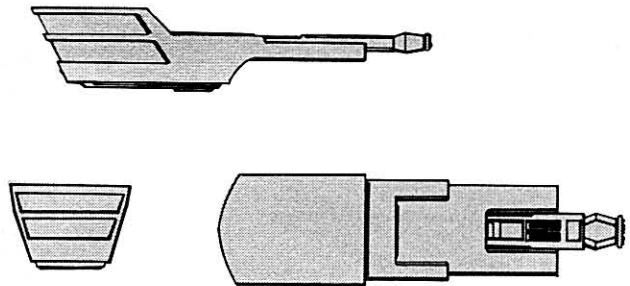

Known Sphere of Operation: Empire-wide use; the Triangle

Data Reliability: A

Major Data Source: All models in Star Fleet possession

Of the 2193 W-2s built, 1087 As, 8 Cs, and 237 Fs remain in active service; 120 As and 16 Fs are used as training vessels; 567 have been destroyed; 46 have been captured, including 24 As and 2 Cs by Star Fleet, 13 As and 2 Fs by the Romulans, 3 As and 1 F by private interests in the Triangle, and 1 A by the Orions; 49 As and 3 Fs are listed as missing; 12 have been scrapped; and 48 have been sold or traded, including 27 As and 2 Fs to private interests in the Triangle, and 17 As and 4 Fs to the Orions. The W-2F is produced at the Taamar, Fonawl, Z'hai, and H'rez facilities at a combined rate of 60 per year; all other models are out of production.

The class is named for a small rodent native to Klinzhai. This creature carries its young in pouches located along its back.

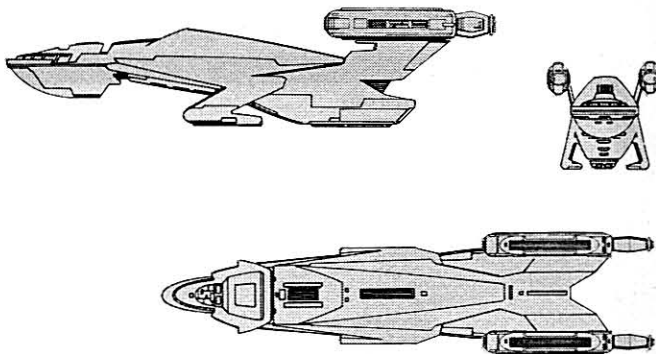

Notes:

Known Sphere Of Operation: Empire-wide use; the Triangle

Data Reliability: A

Major Data Source: All models in Star Fleet possession

Of the 988 W-4s built, 437 As and 355 Bs remain in active service; 8 As and 4 Bs are used as training vessels; 113 have been destroyed; 15 have been captured, including 7 As and 1 B by Star Fleet, 3 As and 2 Bs by the Romulans, and 1 A and 1 B by private interests in the Triangle; 18 As and 7 Bs are listed as missing; and 31 have been traded or sold, including 16 As and 5 Bs to private interests in the Triangle, and 8 As and 2 Bs to the Orions. The W-4 is produced at the Taamar, Fonawl, and Z'hai facilities at a combined rate of 50 per year.

The name is from the Klingon *kas maal*.



W-4 (Speedstar) CLASS III WARPSHUTTLE

Construction Data:

Model Numbers—	A	B
Date Entering Service—	2,1110	2,1504
Number Constructed—	594	394

Hull Data:

Superstructure Points—	4	5
Damage Chart—	C	C
Size		
Length—	90 m	90 m
Width—	20 m	20 m
Height—	20 m	20 m
Weight—	21,100 mt	24,300 mt

Cargo		
Cargo Units—	30 SCU	30 SCU
Cargo Capacity—	1,500 mt	1,500 mt
Landing Capability—	Yes	Yes

Equipment Data:

Control Computer Type—	ZD-3	ZD-4
Transporters—		
standard 6-person cargo	1	1
	1	1

Other Data:

Crew—	10	10
Passengers—	20	20

Engines And Power Data:

Total Power Units Available—	21	21
Movement Point Ratio—	1/1	1/1
Warp Engine Type—	KWB-1	KWB-1
Number—	2	2
Power Units Available—	9	9
Stress Charts—	O.Q	O.Q
Maximum Safe Cruising Speed—	Warp 7	Warp 7
Emergency Speed—	Warp 8	Warp 8
Impulse Engine Type—	KIB-1	KIB-1
Power Units Available—	3	3

Weapons And Firing Data:

Beam Weapon Type—	KD-10	KD-2
Number—	2	2
Firing Arcs—	1f p, 1f s	1f p, 1f s
Firing Chart—	C	G
Maximum Power—	3	4
Damage Modifiers—		
+ 1	(1 - 6)	(1 - 10)

Shields Data:

Deflector Shield Type—	KSI	KSD
Shield Point Ratio—	1/1	1/1
Maximum Shield Power—	14	12

Combat Efficiency:

D.WDF—	55.2/1.4	83.1/2.8
--------	----------	----------

S-4 (Mender) CLASS VI REPAIR TENDER

Construction Data:

Model Numbers —	A	B
Date Entering Service —	2,0607-2/2202	2/1801
Number Constructed —	410	106

Hull Data:

Superstructure Points —	12	12
Damage Chart —	C	C
Size		
Length —	90 m	90 m
Width —	101 m	101 m
Height —	40 m	40 m
Weight —	76,600 mt	88,600 mt

Cargo

Cargo Units —	110 SCU	110 SCU
Cargo Capacity —	5,500 mt	5,500 mt
Landing Capability —	Yes	Yes

Equipment Data:

Control Computer Type —	ZD-5	ZD-5
Transporters —		
standard 6-person cargo	2	2
	1	1

Other Data:

Crew —	108	115
Passengers —	5	5
Shuttlecraft —	2	2

Engines And Power Data:

Total Power Units Available —	32	40
Movement Point Ratio —	3/1	4/1
Warp Engine Type —	KWC-1	KWD-1
Number —	2	2
Power Units Available —	14	18
Stress Charts —	L/O	L/N
Maximum Safe Cruising Speed —	Warp 7	Warp 6
Emergency Speed —	Warp 8	Warp 8
Impulse Engine Type —	KIC-2	KIC-2
Power Units Available —	4	4

Weapons And Firing Data:

Beam Weapon Type —	KD-1	KD-14
Number —	4	4
Firing Arcs —	1f p, 1f s, 1a p, 1a s	1f p, 1f s, 1a p, 1a s
Firing Chart —	B	D
Maximum Power —	4	8
Damage Modifiers —	+ 2	(1 - 6)

Shields Data:

Deflector Shield Type —	KSF	KSF
Shield Point Ratio —	2.3	2.3
Maximum Shield Power —	10	10

Combat Efficiency:

D/WDF —	53.9/2.8	53.2/8.4
---------	----------	----------

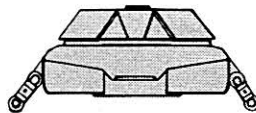
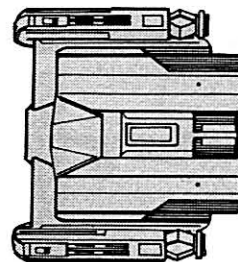

Notes:

Known Sphere Of Operation: Empire-wide use, frequently operates in the Triangle

Data Reliability: A for S-4A; C for S-4B

Major Data Source: Model A in Star Fleet possession; Klingon Sector Intelligence

Of the 516 S-4s built, 431 remain in active service, 2 are used as training vessels, 29 have been destroyed, 5 have been captured (1 A and 2 Bs by Star Fleet, and 2 As and 1 B by private interests in the Triangle), 2 As and 1 B are listed as missing, 10 have been scrapped, and 21 have been sold or traded (6 As and 3 Bs to the Orions, 8 As and 3 Bs to private interests in the Triangle, and 1 A to the Romulans. The S-4 is being produced at the Taamar, Gnuu Re', and Mustaka facilities at a combined rate of 21 per year. All active S-4As have been converted to the B model.

The name, a reference to its repair function, is from the Klingon *k'nall*.

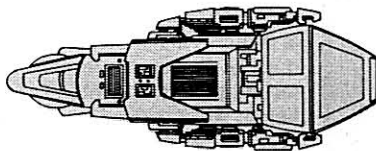
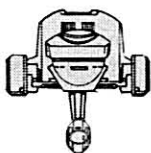
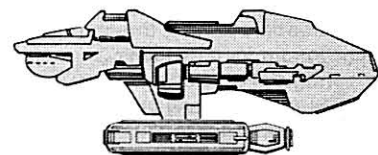

S-5 (Healer) CLASS IV REPAIR TENDER

Construction Data:

Model Numbers —	A
Date Entering Service —	2,0412
Number Constructed —	262

Hull Data:

Superstructure Points —	5
Damage Chart —	B
Size	
Length —	185 m
Width —	70 m
Height —	70 m
Weight —	35,360 mt

Cargo

Cargo Units —	300 SCU
Cargo Capacity —	15,000 mt
Landing Capability —	None

Equipment Data:

Control Computer Type —	ZD-3
Transporters —	
standard 6-person cargo	2
small cargo	2
large cargo	2

Other Data:

Crew —	36
Shuttlecraft —	10

Engines And Power Data:

Total Power Units Available —	17
Movement Point Ratio —	2/1
Warp Engine Type —	KWC-1
Number —	1
Power Units Available —	14
Stress Charts —	K/N
Maximum Safe Cruising Speed —	Warp 7
Emergency Speed —	Warp 8
Impulse Engine Type —	KIB-1
Power Units Available —	3

Weapons And Firing Data:

Beam Weapon Type —	KD-2
Number —	2
Firing Arcs —	2f p s
Firing Chart —	G
Maximum Power —	4
Damage Modifiers —	+ 1
	(1 - 10)

Shields Data:

Deflector Shield Type —	KSI
Shield Point Ratio —	1.1
Maximum Shield Power —	14

Combat Efficiency:

D/WDF —	39.1/2.8
---------	----------

Notes:

Known Sphere Of Operation: All Border areas

Data Reliability: A

Major Data Source: Vessel in Star Fleet possession

Of the 262 S-5s built, 237 remain in active service, 2 are used as training vessels, 16 have been destroyed, 4 have been captured (2 by Star Fleet and 2 by the Romulans), 1 is listed as missing, 1 has been scrapped, and 1 has been sold to private interests in the Triangle. The S-5 is produced at the Gnuu Re' facility at a rate of 12 per year.

The name is a reference to the duties of the vessel; the Klingon class name is *Eakin K'nall*, which translates to "ear healer".



S-8 (Murph) CLASS VI MOBILE REPAIR FACILITY



Traveling Mode

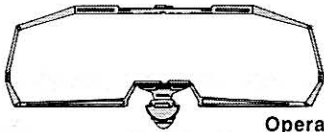

Operational Mode

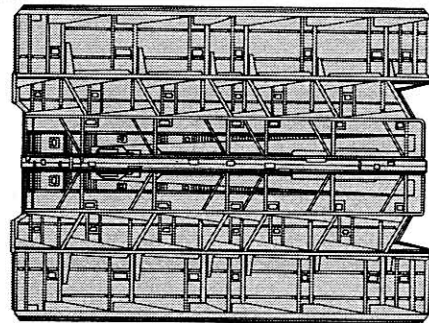
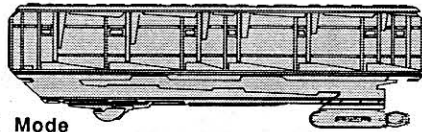

Construction Data:

Model Numbers—	A	B
Date Entering Service—	2/1208	2/2003
Number Constructed—	344	280

Hull Data:

Superstructure Points—	15	15
Damage Chart—	C	C
Size		
Length—	259 m	259 m
Width—	191 m	191 m
Height—	76 m	76 m
Weight—	75,500 mt	76,900 mt

Cargo

Cargo Units—	100 SCU	200 SCU
Cargo Capacity—	5,000 mt	10,000 mt
Landing Capability—	None	None

Equipment Data:

Control Computer Type—	ZD-5	ZD-5
Transporters—		
standard 6-person	2	2
emergency 18-person cargo	1	1
	2	2

Other Data:

Crew—	142	166
Passengers—	60	80
Shuttlecraft—	2	4

Engines And Power Data:

Total Power Units Available—	20	24
Movement Point Ratio—	4/1	3/1
Warp Engine Type—	KWE-2	KWE-3
Number—	1	1
Power Units Available—	16	20
Stress Charts—	I/M	L/M
Maximum Safe Cruising Speed—	Warp 6	Warp 7
Emergency Speed—	Warp 7	Warp 8
Impulse Engine Type—	KIC-2	KIC-2
Power Units Available—	4	4

Weapons And Firing Data:

Beam Weapon Type—		KD-12
Number—		2
Firing Arcs—		1f/p/s, 1a/p/s
Firing Chart—		H
Maximum Power—		9
Damage Modifiers—		
+3		(1 - 3)
+2		(4 - 8)
+1		(9 - 10)

Shields Data:

Deflector Shield Type—	KSG	KSG
Shield Point Ratio—	1/2	1/2
Maximum Shield Power—	11	11

Combat Efficiency:

D/WDF—	51.5/0	58.5/7.4
--------	--------	----------

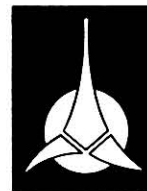

Notes:

Known Sphere Of Operation: Empire-wide use; the Triangle
Data Reliability: C

Major Data Source:

Klingon Sector Intelligence, Operation Dixie

The S-8 was the first mobile repair facility in known space. Lessons learned during the Four Years War, during which front-line repair of warships was inefficient, showed that faster repair capabilities were needed. The only way this could be accomplished was to take the facility to the area of conflict, and the Imperial Command constructed a vessel that would be capable of traveling with the fleets and performing any repairs. On Stardate 2/1208, the first S-8s were commissioned and sent to join various fleets.

The S-8 has two configurations, one for travel (shown in the accompanying three-quarter view) and one for operation (shown in the three views). After arriving at its destination, the S-8 unfolds into its operational mode and begins repairing damaged vessels. In most cases, the damaged ship is brought inside the S-8 so that all damage can be repaired quickly. Damaged vessels are arranged in and around the facility to take advantage of its structural cranes and tractor fields. An S-8 repairing several different ships at once will give the most peculiar readings on sensor scan.

When the MRFs were first commissioned, they were considered to be so unmaneuverable that mounting weapons was impractical. To avoid the shame of commanding an unarmed vessel, two to five gunboats are assigned to its protection and are under the command of the S-8's captain. The B model is armed with two disruptors, and recent intelligence reports indicate that the S-8As are modifying themselves to the S-8B configuration.

Of the 362 S-8s built, 74 As and 279 Bs remain in active service, 2 As are used as training vessels, 2 have been destroyed, 1 A is listed as missing, 3 have been scrapped, and 1 A has been sold to private interests in the Triangle. The S-8s are officially being produced at Iosia, but some have been manufactured by other S-8's.

The class name is from the abbreviation of the vessel type, MRF; the Klingon class name is *H'ban Pav*, which translates to "folding box".

Z-4 (Deathgame) DEFENSE OUTPOST

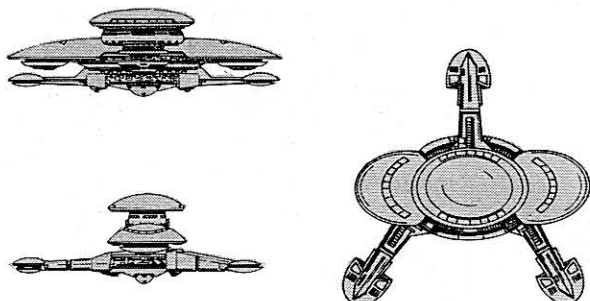

Construction Data:		
Model Numbers —	B	C
Date Entering Service —	1/8902-2/1911	2/1403
Number Constructed —	311	201
Hull Data:		
Superstructure Points —	60	70
Damage Chart —	C	C
Size		
Length —	320 m	320 m
Width —	300 m	300 m
Height —	110 m	110 m
Weight —	1,800,000 mt	1,850,000 mt
Cargo		
Cargo Units —	1,100 SCU	1,200 SCU
Cargo Capacity —	55,000 mt	60,000 mt
Landing Capability —	None	None
Equipment Data:		
Control Computer Type —	ZD-5A	ZD-8
Transporters —		
standard 6-person	6	6
combat 22-person	4	4
emergency 18-person	4	4
cargo	3	3
Other Data:		
Crew —	440	455
Passengers —	260	260
Shuttlecraft —	24	24
Engines And Power Data:		
Total Power Units Available —	164	198
Movement Point Ratio —	10/1	10/1
Warp Engine Type —		
Number —	KMAPG-2	KMAPG-3
Power Units Available —	1	1
Impulse Engine Type —	144	170
Power Units Available —	KIPG-2	KIPG-3
	20	28
Weapons And Firing Data:		
Beam Weapon Type —		
Number —	KD-6	KD-8
Firing Arcs —	12	18
Firing Chart —	4/ARC	6/ARC
Maximum Power —	T	U
Damage Modifiers —	6	7
+3	(1 - 3)	(1 - 7)
+2	(4 - 8)	(8 - 15)
+1	(9 - 10)	(16 - 20)
Beam Weapon Type —		
Number —	KD-12	KD-12
Firing Arcs —	9	3/ARC
Firing Chart —	H	H
Maximum Power —	9	9
Damage Modifiers —		
+3		(1 - 3)
+2		(4 - 8)
+1		(9 - 10)
Missile Weapon Type —		
Number —		KP-6
Firing Arcs —		6
Firing Chart —		2/ARC
Power To Arm —		R
Damage —		2
		20
Shields Data:		
Deflector Shield Type —	KS	KS
Shield Point Ratio —	1/2	1/2
Maximum Shield Power —	15	15
Combat Efficiency:		
DWDF —	153.8/83.4	178/178.5



Notes:

Known Sphere Of Operation: Empire Borders

Data Reliability: B

Major Data Source: Klingon Sector Intelligence

Beginning in Stardate 1/8902, five years prior to the outbreak of the Four Years War, the Klingons began to supplement their forward listening posts with the Z-4. These fortresses were placed in the areas where the Klingons wished to deny or restrict enemy movement. Since their introduction, the Klingons have constantly added to their number. Major defense points (such as starbases) will have more than one Z-4. Several points along the Federation and Triangle border are known to have as many as eight, each giving the others covering fire.

The Z-4 is so large that it must be built in place; if one must ever be moved, it is disassembled into six different sections and each one brought to the new location. Most of these outposts are found within a planetary system, but some areas requiring defensive boundaries do not have this luxury.

When first introduced, the Z-4 was capable of fulfilling its mission completely as designed, but with ships becoming more and more powerful, it was inevitable that they be upgraded. The Z-4A remained in service for 30 years before all were refitted.

On Stardate 2/1403, the first of the replacement outposts, the Z-4C, was commissioned. This model uses the KMAPG-3 powerplant and the KIPG-3 impulse generator. The weapons systems have been upgraded by increasing the number and power of long-range disruptors and the number of close-defense disruptors; in addition, the formidable KP-6 has been mounted to fire 2 torpedoes per arc. With this increase in weaponry, and an offensive range of 200,000 km, the Z-4C is not a likely target for small groups of ships.

Since the introduction of the Z-4C, the production rate has averaged 23 per year. Reports indicate that a faction within the Triangle is attempting to purchase one of these facilities.

In the Klingon navy, command of these outposts is not sought after. The duty is considered to be demeaning as it doesn't allow many chances, if any, for glory in combat. The commanders of these bases have a great deal of power in their hands nevertheless. The bases are usually accompanied by repair facilities and other much needed diversions for front line units, all under the base commander's jurisdiction.

The name is a translation of the Klingon *zha mortas*.

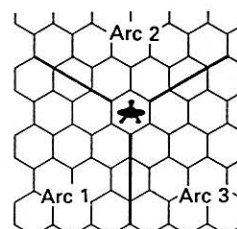

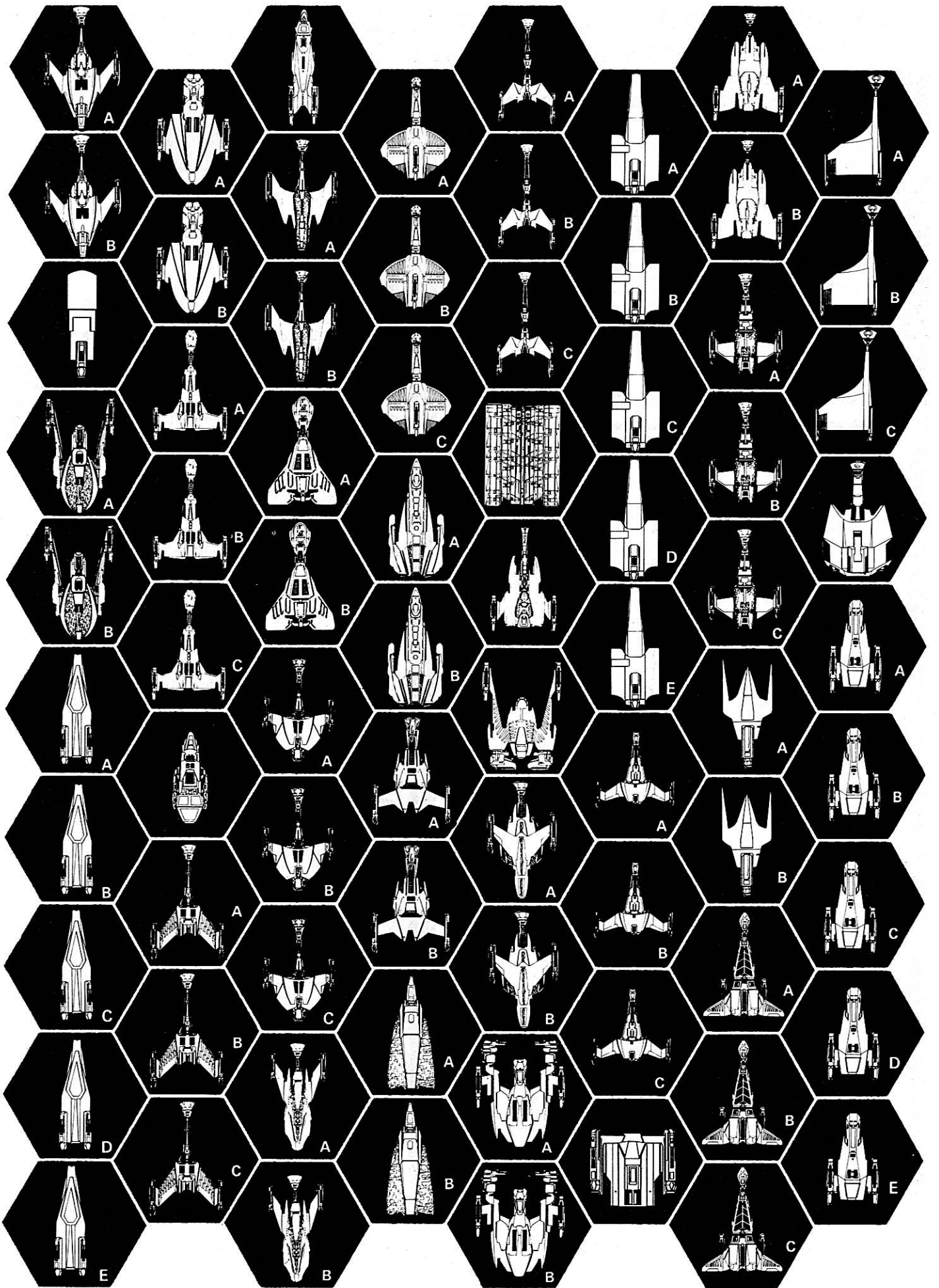

*These counters are to be used as playing pieces.
Glue onto cardboard and cut on solid white lines.*

CLASSIFIED AUTHORIZED PERSONNEL ONLY

The **Klingon Ship Recognition Manual** is intended for Star Fleet personnel with a "need to know" concerning information on the Imperial Klingon Navy. This comprehensive study discloses, for the first time, all known combat, visual, and historical data on 42 different Klingon ships and their variants. Also included is a chronology of service and silhouette recognition chart. This manual is a must for all *Star Trek* enthusiasts.

Shown on the cover is a cutaway view of the D-20 (Death Rite) class cruiser.

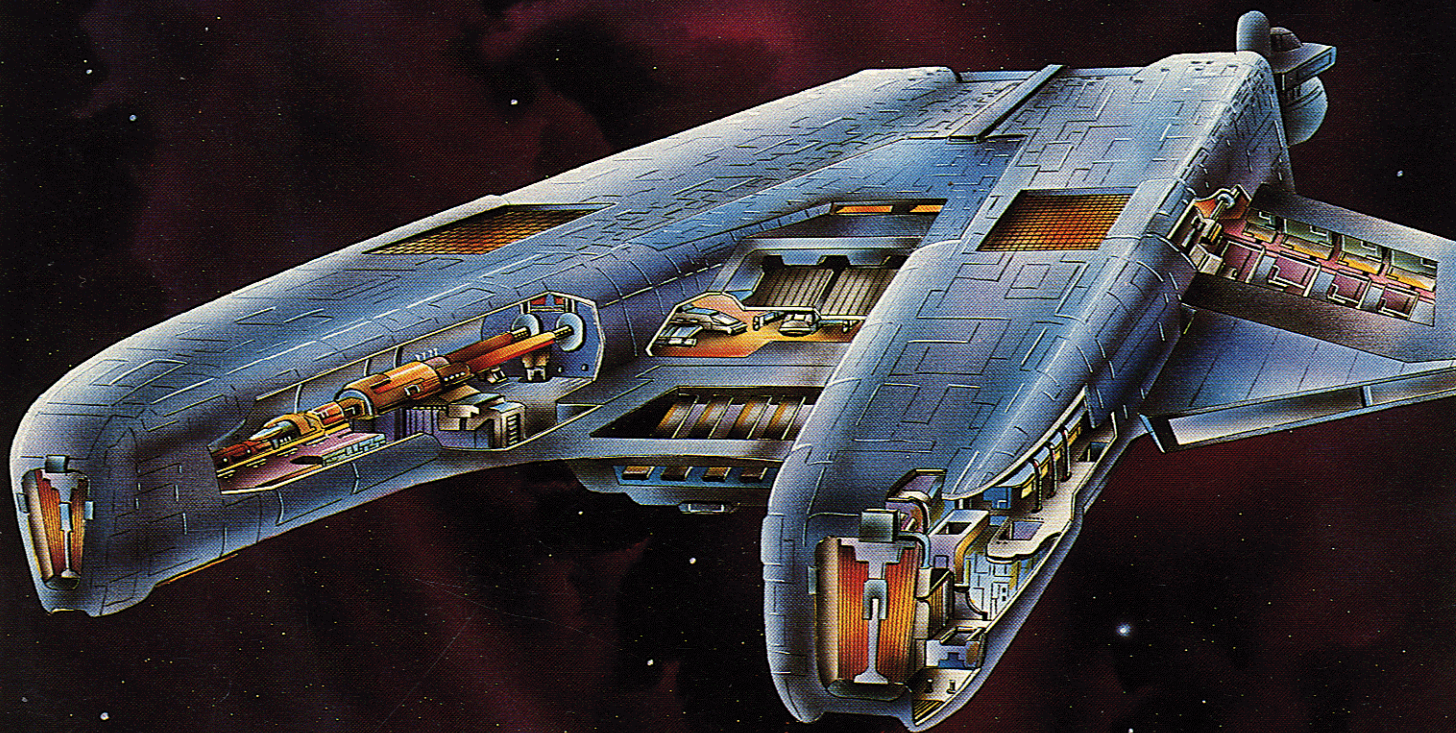

STAR TREK is a trademark of Paramount Pictures Corporation.
Copyright 1985 Paramount Pictures Corporation
All Rights Reserved
Printed in the United States of America



ISBN 0-931787-41-6 FASA700